



Genel Katalog



Genel  
Katalog



GK-T-5000-2011





Sürdürülebilir ve aydınlık bir gelecek için  
**yeni nesil teknolojiler...**



**V:KO**

Sürdürülebilir ve  
aydınlık gelecek için

**yeni nesil teknolojiler.**



VİKO olarak, sürdürülebilir gelişimin, topluma yapılan katkıyla ve doğal kaynakların bilinçli kullanılmasıyla mümkün olabileceğine inanıyoruz. Mevcut enerjilerin ve doğal kaynakların daha verimli kullanımı için gerekli önlemleri alıyoruz. Ürünlerimizde, tasarım aşamasında, üretimde ve kullanımda, çevreye olumsuz olabilecek etkileri en aza indirecek malzeme ve teknolojileri tercih ediyoruz. Görüyoruz, gelecek daha yeşil ve daha aydınlık.



[www.viko.com.tr](http://www.viko.com.tr)





VİKO, İstanbul Sancaktepe’de 50.000 m<sup>2</sup> kapalı alana sahip, Türkiye’nin sektöründeki en büyüğü olarak tanımlanan endüstriyel tesislerinde elektrik enerjisinin aktarılması, kullanılması ve daha kolay sunumu amacıyla çözümler üretmektedir.

VİKO’nun ürün gamı içerisinde elektrik anahtar ve prizleri, grup prizler, sigorta kutuları, aksesuarlar, koruma ve kumanda amaçlı otomatik sigortalardan açık tip kesicilere, kontaktörlerden motor koruma şalterlerine, enerji yönetimi ve ölçme alanında ise monofaze, trifaze ve kombi elektronik sayaçları yer almaktadır.

VİKO, Türkiye pazarlarında liderliğini korurken, satışlarının yüzde 50’si 70 ülkeye yaptığı ihracattan oluşmaktadır. Dünya pazarlarında da başarıyla ülkemizi temsil etmekte ve pek çok yeni ürün piyasaya sunmak için, AR-GE, tasarım ve markalaşma yatırımlarını hızla sürdürmektedir.

Thea marka anahtar serilerinde dünyada ilk kez Led teknolojisi ile anahtarı buluşturan VİKO, dünyada bir ilki gerçekleştirerek birçok farklı kuruluş tarafından ödüle layık görülmüştür. “Türkiye’nin İlk 500 Büyük Sanayi Kuruluşu” içerisinde 329’uncu sırada yer alan VİKO, ISO 9001 Kalite Yönetim Sistemi, ISO 14001 Çevre Yönetim Sistemi, OHSAS 18001 İş Sağlığı ve Güvenliği Yönetim Sistemi belgeleri ve TÜSİAD-KALDER Ulusal Kalite Başarı Ödülü sahibidir. Sektöründe Turquality marka destek programı kapsamına alınan ilk kuruluştur.









Genel  
Katalog

- 8/15** Karre  
**16/21** Carmen Opak  
**22/27** Carmen Plus  
**28/33** Kardelen  
**34/39** Yasemin  
**40/45** Vera (Sıva Üstü)  
**46/51** Palmiye IP54 (Nemli Yer Serisi)  
**52/59** Sigorta Kutuları  
**60/67** Grup Priz ve Aksesuarlar  
**68/78** Teknik Özellikler



## Ürün Grupları

### Karre



Beyaz



Krem

### Carmen Opak



Beyaz



Krem

### Carmen Plus



Beyaz



Krem

### Kardelen



Beyaz



Krem

### Yasemin



Beyaz



Krem



### Vera



Beyaz



Krem



Maun



Meşe

### Palmiye



Gri



Krem



Beyaz

### Sigorta Kutuları



Mühürlü



Siva altı



Siva üstü

### Grup Priz ve Aksesuarlar



Leylak



Lale



Yonca





Karre

Minimal şıklık





## Karre



### Ana Renkler



Beyaz



Krem

Yaşam alanlarının güzelliğini tek bir dokunuşla tamamlayan VIKO, bulunduğu mekanlarda sektör liderliğini yansıtıyor. Sürdürülebilir aydınlık bir gelecek hedefinin ışığında, keskin hatlara ve soylu renklere sahip, minimalist Karre serisiyle, şıklığı hayatın bir parçası yapıyor.

Karre, Easy Connect özelliği sayesinde elektrik kablosuna kolayca bağlanıyor. Yuvasına hemen oturuyor. Beyaz ve Krem renk seçenekleriyle Karre anahtar ve priz serisi, ikili, üçlü, dördü, beşli, altılı yatay ve dikey çerçeveleriyle farklı kullanım alanları için alternatif çözümler sunuyor.

### Sıva Üstü Kasalar



Sıva Üstü Beyaz



Sıva Üstü Krem



Sıva Üstü Beyaz Kasa  
90969001



Sıva Üstü Krem Kasa  
90969011

Sıva üstü kullanımlar için, sıva üstü kasalar en ideal çözümü sunmaktadır. Karre ürün grubuna ait bütün ürünler sıva üstü kasaları ile birlikte kullanılabilir.



## Yatay Çerçevesler



**İkili Yatay Çerçeve**  
909602X1  
90966401  
(154 x 81 mm)



**Üçlü Yatay Çerçeve**  
909602X2  
90966402  
(225 x 81 mm)



**Dörtlü Yatay Çerçeve**  
909602X3  
90966403  
(296 x 81 mm)



**Beşli Yatay Çerçeve**  
909602X4  
90966404  
(367 x 81 mm)



**Altılı Yatay Çerçeve**  
909602X5  
90966405  
(438 x 81 mm)

## Dikey Çerçevesler



**İkili Dikey Çerçeve**  
909602X1  
90966411  
(81 x 154 mm)



**Üçlü Dikey Çerçeve**  
909602X2  
90966412  
(81 x 225 mm)



**Dörtlü Dikey Çerçeve**  
909602X3  
90966413  
(81 x 296 mm)



**Beşli Dikey Çerçeve**  
909602X4  
90966414  
(81 x 367 mm)



**Altılı Dikey Çerçeve**  
909602X5  
90966415  
(81 x 438 mm)

Karre beyaz ve krem çerçeve seçenekleri;  
ikili, üçlü, dörtlü, beşli ve altılı yatay ve dikey  
uygulama çözümleri sunmaktadır.

## Ürün Ölçüleri

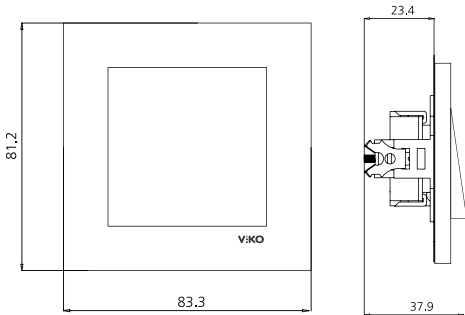



**Anahtar**  
90960X01  
90966001



**Işıklı Anahtar**  
90960X19  
90966019



**Light Anahtar**  
90960X03  
90966003



**Işıklı Light Anahtar**  
90960X14  
90966014



**Kapı Otomatığı Anahtar**  
90960X05  
90966005



**Zil Anahtar**  
90960X06  
90966006



**Işıklı Etiketli Zil Anahtar**  
90960X27  
90966027



**Permütatör (Ara Veavien)**  
90960X31  
90966031



**Veavien**  
90960X04  
90966004



**Işıklı Veavien**  
90960X63  
90966063



**Komütatör Veavien**  
90960X17  
90966017



**Komütatör**  
90960X02  
90966002



**Işıklı Komütatör**  
90960X50  
90966050



**Üçlü Anahtar**  
90960X68  
90966068



**Tek Düğmeli Jaluzi Anahtar**  
90960X72  
90966072



**Jaluzi Kumanda Anahtar**  
90960X16  
90966016



**600W RL Dimmer**  
90960X20  
90966020



**1000W RL Dimmer**  
90960X69  
90966069



**400W RC Dimmer**  
90960X47  
90966047



**Veavien Dimmer**  
90960X40  
90966040



**Müzik Yayın Anahtar**  
90960X54  
90966054



**Müzik Yayın Anahtar**  
90960X80  
90960X28 (Acil Anonslu Trafo)  
90966080  
90966028 (Acil Anonslu Trafo)



**Kanal Seçme Anahtar**  
90960X82  
90966082



**Priz**  
90960X07  
90966007



**Çocuk Korumalı Priz**  
90960X43  
90966043



**Topraklı Priz**  
90960X08  
90966008



**Çocuk Korumalı Topraklı Priz**  
90960X42  
90966042



**Çocuk Korumalı Kapaklı Topraklı Priz**  
90960X12  
90966012



**Çocuk Korumalı UPS Priz**  
90960X45  
90966045



**İkili Priz**  
90960X55  
90966055





**Çocuk Korumalı İkili Priz**  
90960X46  
90966046



**İkili Topraklı Priz**  
90960X56  
90966056



**Çocuk Korumalı İkili Topraklı Priz**  
90960X58  
90966058



**Çocuk Korumalı İkili UPS Priz**  
90960X57  
90966057



**TV Prizi Dirençsiz**  
90960X49  
90966049



**TV Radyo Prizi Sonlu (TV-RD)**  
90960X21  
90966021



**Uydu Prizi F Konnektörü**  
90960X09 Sonlu  
90960X38 Geçişli (10dB)  
90966009 Sonlu  
90966038 Geçişli (10dB)



**TV Uydu Prizi Sonlu (TV-SAT)**  
90960X85  
90966085



**TV Radyo Uydu Prizi Sonlu (SAT-TV-RD)**  
90960X41  
90966041



**İkili Uydu Prizi Sonlu (SAT-SAT-TV)**  
90960X53  
90966053



**Müzik Yayın Prizi**  
90960X37  
90966037



**Tekli Nümeris Prizi - RJ11**  
90960X13  
90966013



**İkili Nümeris Prizi - 2xRJ11**  
90960X33  
90966033



**Data - Nümeris Prizi (RJ11-RJ45)**  
90960X35 (Cat5e)  
90960X81 (Cat6)  
90966035 (Cat5e)  
90966081 (Cat6)



**Data Prizi Jaksız**  
90960X73  
90966073



**Tekli Data Prizi - RJ45**  
90960X32 (Cat5e)  
90960X78 (Cat6)  
90966032 (Cat5e)  
90966078 (Cat6)



**İkili Data Prizi - 2XRJ45**  
90960X34  
90966034



**Kablo Çıkış Kapağı**  
90960X77  
90966077



**Energy Saver Standart**  
90960X51  
90966051



**Energy Saver Barkodlu**  
90960X65  
90966065



**Energy Saver RF**  
90960X\*\*  
909660\*\*

karre

antibacterial



Daha sağlıklı, temiz ve  
mikroplardan uzak bir yaşam için  
VİKO'dan KARRE ANTİBAKTERİYEL.



**KARRE ANTİBAKTERİYEL,  
ÇÜNKÜ TEMİZLİK ÖNEMLİDİR.**

- Gümüş iyonlarıyla antibakteriyel özellik
- Işığa ve sıcaklığa karşı dayanıklı
- Kendi kendini temizleyebilme
- Sağlıklı
- Hijyenik

Özellikle bağışıklık sistemi onları koruyacak kadar güçlü olmayan çocuklar ve daha hijyenik bir ortam arayanlar için VİKO'dan antibakteriyel özellikli anahtar serisi: KARRE ANTİBAKTERİYEL. İnorganik nano gümüş iyonlarıyla etkin antibakteriyel özelliğe sahip KARRE, mikropları hayatımızın dışına çıkarıyor. Evlerde, okullarda, hastanelerde, alışveriş merkezlerinde ve ortak kullanılan tüm mekanlarda daha sağlıklı ve daha hijyenik bir hayat için KARRE ANTİBAKTERİYEL...



## KARRE ANTİBAKTERİYEL... VİKO'DAN ÜZERİNDE BAKTERİ TUTMAYAN BİR SERİ.

VİKO, yeni antibakteriyel özellikli KARRE ile okul, kreş, spor salonları, hastane gibi kalabalık alanlarda ve evlerinde mikroplardan etkilenmeden yaşamak isteyenler için önemli bir adım atıyor. Hemen her gün temas ettiğimiz alanların çoğalan bakterilere, mantarlara, küfe ve kötü kokuyla

## MİKROPLARA VE BAKTERİLERE KARŞI EVLERDE, OKULLARDA, KREŞLERDE, HASTANELERDE, SPOR SALONLARINDA KARRE ANTİBAKTERİYEL.

KARRE ANTİBAKTERİYEL yüzeyindeki özel maddesiyle mikropları öldürmek için savaşıyor. Kısaca kendi kendini temizliyor. Günboyu, mikrop üremesine mani oluyor. KARRE ANTİBAKTERİYEL gücünü ve özelliğini gümüş iyonlarından alıyor. Peki, neden gümüş? Çünkü, gümüş oldukça uzun bir kullanım geçmişine sahip. Gümüşe dayalı antibakteriyel yüzeyler rahatlıkla bakterilerin yol açtığı kokulara, küfün neden olduğu lekeler ve renk değişimlerine karşı savaşabiliyorlar. Mikroplar yüzeylerinde eksi yüke sahiptirler ve artı yüke sahip gümüş iyonlarını kendilerine doğru çekerler.



birlikte kire neden olan diğer mikroplara karşı korumalı olduğunu hayal edin. İşte, KARRE ANTİBAKTERİYEL böyle bir fikirden doğdu.

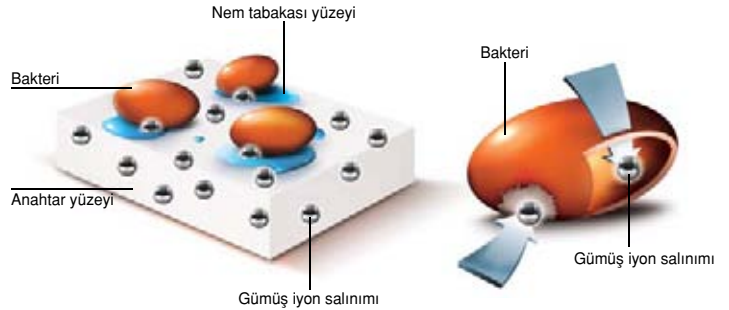

Gümüş iyonlu KARRE, ihtiyaç oldukça ortaya çıkan gümüş salınımı ile hem mikropların iç dengesini bozuyor hem de onları etkisiz hale getiriyor.

Üstelik VİKO KARRE'nin antibakteriyel yapısı ışık ve sıcaklıktan da etkilenmiyor. Mikroplara karşı sizin için mücadele ediyor.



**Carmen**  
Opak

Hayatı şıklaştıran tasarım







## Carmen Opak



### Ana Renkler



Beyaz



Krem

Carmen Opak, hayatın içinden gelen çizgilerle tasarlandı. Ev kadar sıcak tasarımı, zaman kadar akıcı hatları sayesinde şimdi tüm dikkatler onun üzerinde. Dekorasyon tercihleriyle uyumlu bir bütünlük yakalayan Carmen Opak, beyaz, krem renk seçenekleri ve 90'ın üzerinde mekanizma opsiyonuyla sunuluyor. Carmen Opak diğer yandan ikili, üçlü, beşli, altılı olarak yatay ve dikey çerçeve uygulamasıyla da göz dolduruyor.

VİKO kalitesini yaşam alanlarına taşıyan Carmen Opak'ın pratik olarak tek seferde duvara monte olan daimi mekanizması ise ayrıcalıklardan sadece bir tanesi. Farklı kapak ve çerçeve renkleriyle kombine edilebilen bu özel mekanizma ile mekanlar için tek düzelik tarihe karışıyor.

### Sıva Üstü Kasalar



Sıva Üstü Beyaz



Sıva Üstü Krem



Sıva Üstü Beyaz Kasa  
90571009



Sıva Üstü Krem Kasa  
90572009

Sıva üstü kullanımlar için, sıva üstü kasalar en ideal çözümü sunmaktadır. Carmen Opak ürün grubuna ait bütün ürünler sıva üstü kasaları ile birlikte kullanılabilir.

## Yatay Çerçeveler



**İkili Yatay Çerçeve**  
9057Y102  
(153.5 x 80.5 mm)



**Üçlü Yatay Çerçeve**  
9057Y103  
(224.5 x 80.5 mm)



**Dörtlü Yatay Çerçeve**  
9057Y104  
(295.5 x 80.5 mm)



**Beşli Yatay Çerçeve**  
9057Y105  
(366.5 x 80.5 mm)



**Altılı Yatay Çerçeve**  
9057Y106  
(437.5 x 80.5 mm)

## Dikey Çerçeveler



**İkili Dikey Çerçeve**  
9057Y002  
(82.5 x 151.5 mm)



**Üçlü Dikey Çerçeve**  
9057Y003  
(82.5 x 222.5 mm)



**Dörtlü Dikey Çerçeve**  
9057Y004  
(82.5 x 293.5 mm)



**Beşli Dikey Çerçeve**  
9057Y005  
(82.5 x 364.5 mm)



**Altılı Dikey Çerçeve**  
9057Y006  
(82.5 x 435.5 mm)

Carmen Opak beyaz ve krem çerçeve seçenekleri;  
ikili, üçlü, dörtlü, beşli ve altılı yatay ve dikey uygulama çözümleri  
sunmaktadır.

## Ürün Ölçüleri

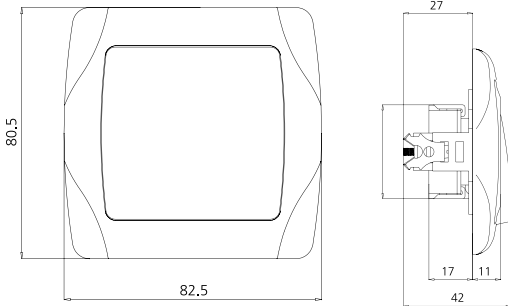



**Anahtar**  
9056X001



**Işıklı Anahtar**  
90960X019



**Light Anahtar**  
9056X003



**Işıklı Light Anahtar**  
9056X014



**Kapı Otomatığı Anahtar**  
9056X005



**Zil Anahtar**  
9056X006



**Işıklı Etiketli Zil Anahtar**  
9056X027



**Permütatör (Ara Veavien)**  
9056X031



**Veavien**  
9056X004



**Işıklı Veavien**  
9056X063



**Komütatör Veavien**  
9056X017



**Komütatör**  
9056X002



**Işıklı Komütatör**  
9056X050



**Üçlü Anahtar**  
9056X068



**Tek Düğmeli Jaluzi Anahtar**  
9056X072



**Jaluzi Kumanda Anahtar**  
9056X016



**600W RL Dimmer**  
9056X020



**1000W RL Dimmer**  
9056X069



**400W RC Dimmer**  
9056X090



**Veavien Dimmer RL**  
9056X040



**Dokunmatik Dimmer**  
9056X076



**Müzik Yayın Anahtar**  
9056X054  
9056X080 (Trafolu)  
9056X091 (Acil Anonslu Trafolu)



**Kanal Seçme Anahtar**  
9056X082



**Priz**  
9056X007



**Çocuk Korumalı Priz**  
9056X043



**Topraklı Priz**  
9056X008



**Çocuk Korumalı Topraklı Priz**  
9056X042



**Çocuk Korumalı UPS Priz**  
9056X045





**İkili Priz**  
9056X055



**İkili Topraklı Priz**  
9056X056



**Çocuk Korumalı İkili UPS Priz**  
9056X057



**Çocuk Korumalı Kapaklı Topraklı Priz**  
9056X012



**TV Priz**  
9056X010 (Sonlu)  
9056X060 (Geçişli)  
9056X049 (Dirençsiz)



**TV Radyo Prizi (TV-RD)**  
9056X021 (Sonlu)  
9056X022-25 (Geçişli)



**Uydu Prizi F Konnektörü**  
9056X096 (Sonlu)  
9056X097 (Geçişli 10dB)



**TV Uydu Prizi (TV-SAT)**  
9056X085 (Sonlu)  
9056X086-87 (Geçişli)



**TV Radyo Uydu Prizi (SAT-TV-RD)**  
9056X041 (Sonlu)  
9056X052 (Geçişli)



**İkili Uydu Prizi (SAT-SAT-TV-RD)**  
9056X053



**Müzik Yayın Prizi**  
9056X037



**Telefon Prizi**  
9056X011



**Nümeris Telefon Prizi (RJ11)**  
9056X013



**İkili Nümeris Telefon Prizi (2 x RJ11)**  
9056X033



**Data-Nümeris Telefon Prizi (RJ45-RJ11)**  
9056X035 (Cat5e)  
9056X335 (Cat6)



**Data Prizi Jaksız**  
9056X132



**Tekli Data Prizi (RJ45)**  
9056X032 (Cat5e)  
9056X332 (Cat6)



**İkili Data Prizi (2 x RJ45)**  
9056X034 (Cat5e)  
9056X334 (Cat6)



**Energy Saver-Standart (Röle Hariç)**  
9056X051  
90551152 (Logolu Anahtarlık)



**Kablo Çıkış Kapağı**  
9056X077



**Energy Saver Kartlı (Röle Hariç)**  
9056X065  
90551163 (Kart)  
9056X0\*\* RF



**Carmen  
Plus**



Seçme özgürlüğü





## Carmen Plus



### Ana Renkler



Beyaz



Krem

VİKO'nun detaylara işleyen profesyonelliği sayesinde Carmen Plus ile yaşam alanları özgürlüğün yeni yüzüyle tanıştı.

Çarpıcı tasarımı, fonksiyonel yapısı ve özgün renk seçenekleri Carmen Plus'ı hemen her mekan için öncelikli tercihler arasında ilk sıralara taşıyor. Beyaz ve krem renk seçenekleri eşliğinde 14 farklı kordon rengiyle özgün kombinasyonlar oluşturma imkanı sunan Carmen Plus'ın uygulandığı mekanlar geleneksel sınırların ötesine geçiyor.

### Sıva Üstü Kasalar



Sıva Üstü Beyaz



Sıva Üstü Krem



Sıva Üstü Beyaz Kasa  
90571009



Sıva Üstü Krem Kasa  
90572009

Sıva üstü kullanımlar için, sıva üstü kasalar en ideal çözümü sunmaktadır. Carmen Plus ürün grubuna ait bütün ürünler sıva üstü kasaları ile birlikte kullanılabilir.



## Yatay Çerçevesler



**İkili Yatay Çerçeve**  
9057X302  
(153.5 x 80.5 mm)



**Üçlü Yatay Çerçeve**  
9057X303  
(224.5 x 80.5 mm)



**Dörtlü Yatay Çerçeve**  
9057X304  
(295.5 x 80.5 mm)



**Beşli Yatay Çerçeve**  
9057X305  
(366.5 x 80.5 mm)



**Altılı Yatay Çerçeve**  
9057X306  
(437.5 x 80.5 mm)

## Dikey Çerçevesler



**İkili Dikey Çerçeve**  
9057X202  
(82.5 x 151.5 mm)



**Üçlü Dikey Çerçeve**  
9057X203  
(82.5 x 222.5 mm)



**Dörtlü Dikey Çerçeve**  
9057X204  
(82.5 x 293.5 mm)



**Beşli Dikey Çerçeve**  
9057X205  
(82.5 x 364.5 mm)



**Altılı Dikey Çerçeve**  
9057X206  
(82.5 x 435.5 mm)

Carmen Plus beyaz ve krem çerçeve seçenekleri; ikili, üçlü, dörtlü, beşli ve altılı yatay ve dikey uygulama çözümleri sunmaktadır.

## Kordon Renkleri



**Beyaz-Kum Beji**  
90611001  
Krem-Kum Beji  
90611041



**Beyaz-Su Yeşilli**  
90611002  
Krem-Su Yeşilli  
90611042



**Beyaz-Bulut Grisi**  
90611003  
Krem-Bulut Grisi  
90611043



**Beyaz-Çelik Grisi**  
90611004  
Krem-Çelik Grisi  
90611044



**Beyaz-Saten Dore**  
90611005  
Krem-Saten Dore  
90611045



**Beyaz-Lal Kırmızısı**  
90611006  
Krem-Lal Kırmızısı  
90611046



**Beyaz-Granit Yeşilli**  
90611007  
Krem-Granit Yeşilli  
90611047



**Beyaz-Tropik Kahve**  
90611008  
Krem-Tropik Kahve  
90611048



**Beyaz-Fırtına Mavisi**  
90611009  
Krem-Fırtına Mavisi  
90611049



**Beyaz-Koyu Fuşya**  
90611010  
Krem-Koyu Fuşya  
90611050



**Bulut Grisi-Çelik Grisi Kombine**  
90611080



**Su Yeşilli-Granit Yeşilli Kombine**  
90611081



**Bulut Grisi-Fırtına Mavisi Kombine**  
90611082



**Saten Dore-Tropik Kahve Kombine**  
90611083

## Ürün Ölçüleri

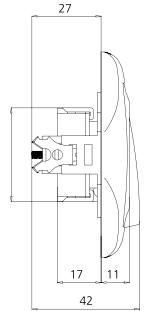
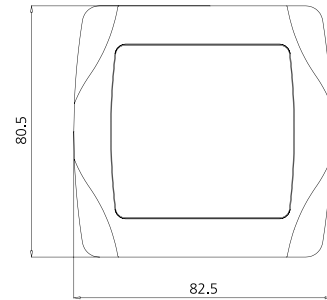



**Anahtar**  
9054XX01



**Işıklı Anahtar**  
9054XX19



**Light Anahtar**  
9054XX03



**Işıklı Light Anahtar**  
9054XX14



**Kapı Otomatiği Anahtar**  
9054XX05



**Zil Anahtar**  
9054XX06



**Işıklı Etiketli Zil Anahtar**  
9054XX27



**Permütatör (Ara Veavien)**  
9054XX31



**Veavien**  
9054XX04



**Işıklı Veavien**  
9054XX63



**Komütatör Veavien**  
9054XX17



**Komütatör**  
9054XX02



**Işıklı Komütatör**  
9054XX50



**Üçlü Anahtar**  
9054XX68



**Tek Düğmeli Jaluzi Anahtar**  
9054XX72



**Jaluzi Kumanda Anahtar**  
9054XX16



**600W RL Dimmer**  
9054XX20



**1000W RL Dimmer**  
9054XX69



**400W RC Dimmer**  
9054XX90



**Veavien Dimmer RL**  
9054XX40



**Dokunmatik Dimmer**  
9054XX76



**Müzik Yayın Anahtar**  
9054XX54  
9054XX80 (Trafolu)  
9054XX91 (Acil Anonlu Trafolu)



**Kanal Seçme Anahtar**  
9054XX82



**Priz**  
9054XX07



**Çocuk Korumalı Priz**  
9054XX43



**Topraklı Priz**  
9054XX08



**Çocuk Korumalı Topraklı Priz**  
9054XX42



**Çocuk Korumalı UPS Priz**  
9054XX45



**İkili Priz**  
9054XX55



**İkili Topraklı Priz**  
9054XX56



**Çocuk Korumalı İkili UPS Priz**  
9054XX57



**Çocuk Korumalı Kapaklı Topraklı Priz**  
9054XX12



**TV Priz**  
9054XX10 (Sonlu)  
9054XX60 (Geçişli)  
9054XX49 (Dirençsiz)



**TV Radyo Prizi (TV-RD)**  
9054XX21 (Sonlu)  
9054XX22-24 (Geçişli)



**Uydu Prizi F Konnektör**  
9054XX96 (Sonlu)  
9054XX97 (Geçişli 10dB)



**TV Uydu Prizi (TV-SAT)**  
9054XX85 (Sonlu)  
9054XX86-87 (Geçişli)



**TV Radyo Uydu Prizi (SAT-TV-RD)**  
9054XX41 (Sonlu)  
9054XX52 (Geçişli)



**İkili Uydu Prizi (SAT-SAT-TV-RD)**  
9054XX53



**Müzik Yayın Prizi**  
9054XX37



**Telefon Prizi**  
9054XX11



**Nümeris Telefon Prizi (RJ11)**  
9054XX13



**İkili Nümeris Telefon Prizi (2 x RJ11)**  
9054XX33



**Data-Nümeris Telefon Prizi (RJ45-RJ11)**  
9054XX35 (Cat5e)  
9054XX95 (Cat6)



**Data Prizi Jaksız**  
9054X132



**Tekli Data Prizi (RJ45)**  
9054XX32 (Cat5e)  
9054X332 (Cat6)



**İkili Data Prizi (2 x RJ45)**  
9054XX34 (Cat5e)  
9054X334 (Cat6)



**Energy Saver-Standart (Röle Hariç)**  
9054X051  
90551152 (Logolu Anahtarlık)



**Kablo Çıkış Kapağı**  
9054XX77



**Energy Saver Kartlı (Röle Hariç)**  
9054X065  
90551163 (Kart)  
9054X0\*\* RF





Kardelen

Zarif bir dokunuş



## Kardelen



### Ana Renkler



Beyaz



Krem

VİKO, Kardelen serisi ile konfor, estetik ve ahenk kavramlarını hayatın baş köşesine yerleştiriyor.

Kardelen saf güzelliğiyle girdiği mekanlara tıpkı bir ışık perisi gibi dokunuyor. Anahtardan uydu prizine zengin ürün yelpazesine ve çoklu çerçeve opsiyonuna sahip olan Kardelen, beyaz ve krem ana renkleriyle kombine edilebilen 16 kordon rengiyle sunuluyor.

### Sıva Üstü Kasalar



Sıva Üstü Beyaz



Sıva Üstü Krem



Sıva Üstü Beyaz Kasa  
90501930



Sıva Üstü Krem kasa  
90503930

Sıva üstü kullanımlar için, sıva üstü kasalar en ideal çözümü sunmaktadır. Kardelen ürün grubuna ait bütün ürünler sıva üstü kasaları ile birlikte kullanılabilir.

## Yatay Çerçeveler



**İkili Çerçeve**  
9050Y922  
(152 x 80 mm)



**Üçlü Çerçeve**  
9050Y923  
(223 x 80 mm)



**Dörtlü Çerçeve**  
9050Y924  
(294 x 80 mm)



**Beşli Çerçeve**  
9050Y925  
(365 x 80 mm)



**Altılı Çerçeve**  
9050Y926  
(436 x 80 mm)

Kardelen beyaz ve krem çerçeve seçenekleri;  
ikili, üçlü, dörtlü, beşli ve altılı uygulama çözümleri sunmaktadır.

## Kordon Renkleri



**Beyaz**  
90601301



**Krem**  
90603701



**Gri**  
90601101



**Krom Kaplama**  
90603601



**Altın Yıldız**  
90601201



**Gümüş**  
90601601



**Maun**  
90601401



**Ceviz**  
90601901



**Su Yeşili**  
90605501



**Nil Yeşili**  
90605201



**Kum**  
90605401



**Somon**  
90605001



**Mavi**  
90603201



**Pembe**  
90603501



**Gül**  
90601701



**Saten**  
90605901

## Ürün Ölçüleri

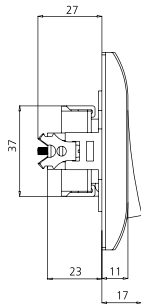
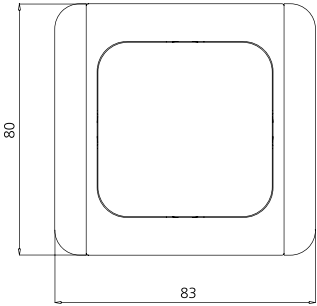



**Anahtar**  
9055X001



**Işıklı Anahtar**  
9055X019



**Light Anahtar**  
9055X003



**Işıklı Light Anahtar**  
9055X014



**Kapı Otomatiği Anahtar**  
9055X005



**Zil Anahtar**  
9055X006



**Işıklı Etiketli Zil Anahtar**  
9055X027



**Permütatör (Ara Veavien)**  
9055X031



**Veavien**  
9055X004



**Işıklı Veavien**  
9055X063



**Komütatör Veavien**  
9055X017



**Komütatör**  
9055X002



**Işıklı Komütatör**  
9055X050



**Tek Düğmeli Jaluzi Anahtar**  
9055X072



**Jaluzi Kumanda Anahtar**  
9055X016



**600W RL Dimmer**  
9055X020



**1000W RL Dimmer**  
9055X069



**400W RC Dimmer**  
9055X090



**Veavien Dimmer RL**  
9055X040



**Müzik Yayın Anahtar**  
9055X054  
9055X080 (Trafolu)  
9055X091 (Acil Anonslu Trafolu)



**Kanal Seçme Anahtar**  
9055X082



**Priz**  
9055X007



**Çocuk Korumalı Priz**  
9055X043



**Topraklı Priz**  
9055X008



**Çocuk Korumalı Topraklı Priz**  
9055X042



**Çocuk Korumalı UPS Priz**  
9055X045



**Çocuk Korumalı Kapaklı Topraklı Priz**  
9055X012

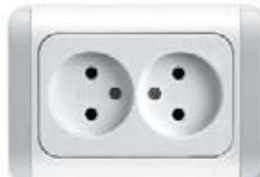

**İkili Priz**  
9055X055



**İkili Topraklı Priz**  
9055X056



**Çocuk Korumalı İkili UPS Topraklı Priz**  
9055X057



**TV Prizi**  
9055X010 (Sonlu)  
9055X060 (Geçişli)  
9055X049 (Dirençsiz)



**TV Radyo Prizi (TV-RD)**  
9055X021 (Sonlu)  
9055X022-25 (Geçişli)



**Uydu Prizi F Konnektörlü**  
9055X096 (Sonlu)  
9054X097 (Geçişli 10 dB)



**TV Radyo Prizi (TV-SAT)**  
9055X085 (Sonlu)  
9054X086-87 (Geçişli)



**TV Uydu Prizi (SAT-TV-RD)**  
9055X041 (Sonlu)  
9055X052 (Geçişli)



**İkili Uydu Prizi (SAT-SAT-TV-RD)**  
9055X053



**Müzik Yayın Prizi**  
9055X037



**Telefon Prizi**  
9055X011



**Nümeris Telefon Prizi (RJ11)**  
9055X013



**İkili Nümeris Telefon Prizi (2xRJ11)**  
9055X033



**Data-Nümeris Telefon Prizi (RJ45-RJ11)**  
9055X035 (Cat5e)  
9055X335 (Cat6)



**Data Prizi Jaksız**  
9055X132



**Tekli Data Prizi (RJ45)**  
9055X032 (Cat5e)  
9055X332 (Cat6)



**İkili Data Prizi (2 x RJ45)**  
9055X034 (Cat5e)  
9055X334 (Cat6)



**Kablo Çıkış Kapağı**  
9055X077



**Energy Saver Standart (Röle Hariç)**  
9055X051  
90551152 (Logolu Anahtarlık)



**Energy Saver Kartlı (Röle Hariç)**  
9055X065  
90551163 (Kart)  
9055X0\*\* RF





Yasemin

İçten dışa mutluluk





## Yasemin



### Ana Renkler



Beyaz



Krem

Yasemin serisi ile artık mekanların yeni bir etki noktası var. Tarz yaratan renk uyumu ve monotonluğu kıran bütünsel bir ahenk için tasarlanan Yasemin, çerçeve içinde çerçeve, şıklık içinde şıklık olarak tanımlanıyor. Beyaz ve krem alternatifine sahip gövde, 16 çeşit tekli ve ikili kordon seçeneğiyle Yasemin serisi imaja öncelik tanıyanlara, geniş ürün yelpazesi arasından tercih yapma lüksünü sunuyor.

### Sıva Üstü Kasalar



Sıva Üstü Beyaz



Sıva Üstü Krem



Sıva Üstü Beyaz Kasa  
90502930



Sıva Üstü Krem kasa  
90504930

Sıva üstü kullanımlar için, sıva üstü kasalar en ideal çözümü sunmaktadır. Kardelen ürün grubuna ait bütün ürünler sıva üstü kasaları ile birlikte kullanılabilir.

## Yatay Çerçeveler



**İkili Yatay Çerçeve**  
9050Y922  
(151 x 84 mm)



**Üçlü Yatay Çerçeve**  
9050Y923  
(222 x 84 mm)



**Dörtlü Yatay Çerçeve**  
9050Y924  
(293 x 84 mm)



**Beşli Yatay Çerçeve**  
9050Y925  
(364 x 84 mm)



**Altılı Yatay Çerçeve**  
9050Y926  
(435 x 84 mm)

Yasemin beyaz ve krem çerçeve seçenekleri;  
ikili, üçlü, dörtlü, beşli ve altılı yatay ve  
dikey uygulama çözümleri sunmaktadır.

## Ürün Ölçüleri

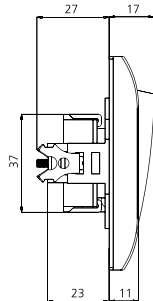
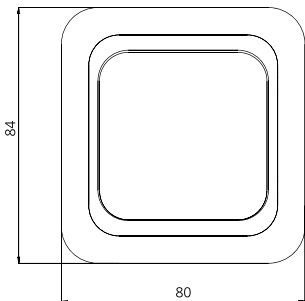

## Tekli Kordon Renkleri



**Beyaz**  
90602201



**Krem**  
90604701



**Gri**  
90602101



**Krom Kaplama**  
90604601



**Gümüş**  
90602501



**Maun**  
90602301



**Ceviz**  
90602801



**Gül**  
90602601



**Nil Yeşil**  
90606201



**Kum**  
90606401



**Somon**  
90606001



**Mavi**  
90604201



**Pembe**  
90604501



**Altın Yıldız**  
90602001



**Su Yeşil**  
90606501



**Saten**  
90604901

## İkili Priz Kordon Renkleri



**Beyaz**  
90614201



**Krem**  
90615701



**Gri**  
90614101



**Krom Kaplama**  
90615601



**Gümüş**  
90614501



**Maun**  
90614301



**Ceviz**  
90614801



**Gül**  
90614601



**Nil Yeşil**  
90616201



**Kum**  
90616401



**Somon**  
90616001



**Mavi**  
90615201



**Pembe**  
90615501



**Altın Yıldız**  
90614001



**Su Yeşil**  
90606501



**Saten**  
90604901





**Anahtar**  
9055X001



**Işıklı Anahtar**  
9055X019



**Light Anahtar**  
9055X003



**Işıklı Light Anahtar**  
9055X014



**Kapı Otomatığı Anahtar**  
9055X005



**Zil Anahtar**  
9055X006



**Işıklı Etiketli Zil Anahtar**  
9055X027



**Permütatör (Ara Veavien)**  
9055X031



**Veavien**  
9055X004



**Işıklı Veavien**  
9055X063



**Komütatör Veavien**  
9055X017



**Komütatör**  
9055X002



**Işıklı Komütatör**  
9055X050



**Üçlü Anahtar**  
9055X068



**Tek Düğmeli Jaluzi Anahtar**  
9055X072



**Jaluzi Kumanda Anahtar**  
9055X016



**600W RL Dimmer**  
9055X020



**1000W RL Dimmer**  
9055X069



**400W RC Dimmer**  
9055X090



**Veavien Dimmer RL**  
9055X040



**Müzik Yayın Anahtar**  
9055X054  
9055X080 (Trafolu)  
9055X091 (Acil Anonslu Trafolu)



**Kanal Seçme Anahtar**  
9055X082



**Priz**  
9055X007



**Çocuk Korumalı Priz**  
9055X043



**Topraklı Priz**  
9055X008



**Çocuk Korumalı Topraklı Priz**  
9055X042



**Çocuk Korumalı UPS Priz**  
9055X045



**Çocuk Korumalı Kapaklı Topraklı Priz**  
9055X012





**İkili Priz**  
9055X055



**İkili Topraklı Priz**  
9055X056



**Çocuk Korumalı İkili UPS Topraklı Priz**  
9055X057



**TV Priz**  
9055X010 (Sonlu)  
9055X060 (Geçişli)  
9055X049 (Dirençsiz)



**TV Radyo Priz (TV-RD)**  
9055X021 (Sonlu)  
9055X022-25 (Geçişli)



**Uydu Priz F Konnektörlü**  
9055X096 (Sonlu)  
9055X097 (Geçişli 10 dB)



**TV Uydu Priz (SAT-TV)**  
9055X085 (Sonlu)  
9055X086-87 (Geçişli)



**İkili Uydu Priz (SAT-SAT-TV-RD)**  
9055X041 (Sonlu)  
9055X052 (Geçişli)



**İkili Uydu Priz (SAT-SAT-TV-RD)**  
9055X053



**Müzik Yayın Priz**  
9055X037



**Telefon Priz**  
9055X011



**Nümeris Telefon Priz (RJ11)**  
9055X013



**İkili Nümeris Telefon Priz (2xRJ11)**  
9055X033



**Data-Nümeris Telefon Priz (RJ45-RJ11)**  
9055X035 (Cat5e)  
9055X335 (Cat6)



**Data Priz Jaksız**  
9055X132



**Tekli Data Priz (RJ45)**  
9055X032 (Cat5e)  
9055X332 (Cat6)



**İkili Data Priz (2 x RJ45)**  
9055X034 (Cat5e)  
9055X334 (Cat6)



**Kablo Çıkış Kapağı**  
9055X077



**Energy Saver Standart (Röle Hariç)**  
9055X051  
90551152 (Logolu Anahtarlık)



**Energy Saver Kartı (Röle Hariç)**  
9055X065  
90551163 (Kart)  
9055X0\*\* RF ID





Vera  
sıva üstü  
IP20



Güvenlik noktası



## Vera sıva üstü IP20



### Ana Renkler



Beyaz



Krem



Maun



Meşe

Vera sıva üstü serisi, yüksek kullanım güvenliği için tam gereken standartlara sahip. Konfor, tasarım, işlevsellik beklentilerini kusursuzca yanıtlayan Vera, beyaz, krem ve ahşap görünüm renk seçenekleri ve dayanıklı yapısıyla en zorlu mekanlarda dahi sağlam bir duruş sergiliyor. Geniş ürün yelpazesi ve kolay monte edilebilme özelliği sayesinde ise kullanım alanlarının her ihtiyacını karşılıyor.





**Anahtar**  
9068XX01



**Işıklı Anahtar**  
9068XX19



**Light Anahtar**  
9068XX03



**Üçlü Anahtar**  
9068XX68



**Işıklı Etiketli Zil Anahtar**  
9068XX27



**Veavien**  
9068XX04



**Işıklı Veavien**  
9068XX63



**Komütatör Veavien**  
9068XX17



**Komütatör**  
9068XX02



**Işıklı Komütatör**  
9068XX50



**Priz**  
9068XX07



**Topraklı Priz**  
9068XX08



**UPS Toprak Priz**  
9068XX45



**İkili Priz**  
9068XX55



**İkili Topraklı Priz**  
9068XX56



**TV Priz**  
9068XXXX (Sonlu)  
9068XX59 (Geçişli 8dB)  
9068XX60 (Geçişli 12dB)  
9068XX61 (Geçişli 18dB)  
9068XX49 (Direncsiz)



**Tekli Nümeris (Cat 3)**  
9068XX13



**Tekli Data (Cat 5)**  
9068XX32





## Dikey Kombinasyon



Anahtar + Priz  
9068XY86



Işıklı Anahtar + Priz  
9068XY90



Veavien + Priz  
9068XY91



Komütatör + Priz  
9068XY89

## Yatay Kombinasyon



Anahtar + Priz  
9068XY86



Işıklı Anahtar + Priz  
9068XY90



Veavien + Priz  
9068XY91



Komütatör + Priz  
9068XY89

## Ürün Ölçüleri

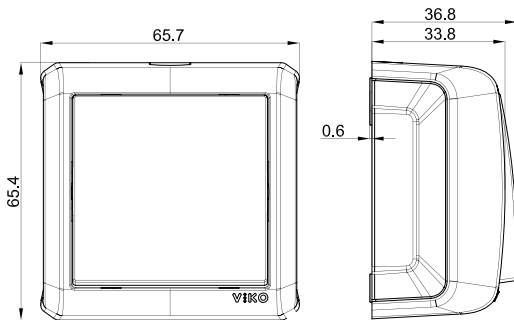

XY KODUNUN KARŞILIĞI: 10 = Dikey Beyaz 20 = Dikey Meşe  
11 = Yatay Beyaz 21 = Yatay Meşe  
12 = Dikey Krem 22 = Dikey Maun  
13 = Yatay Krem 23 = Yatay Maun

## Montaj şekli

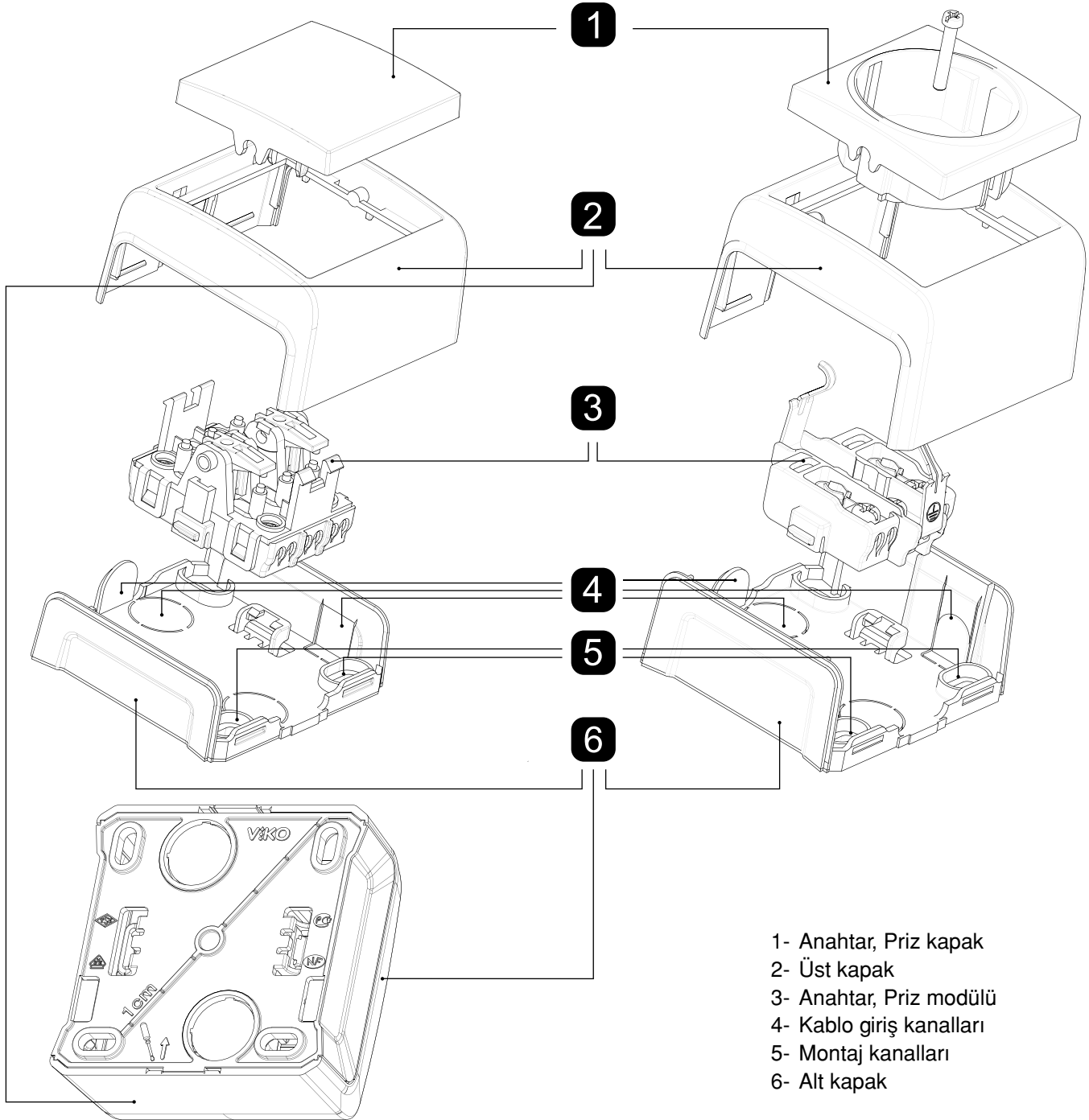

Priz için öncelikle üst kapak üzerindeki vidayı gevşetin.

Alt kapakta yer alan (6) tornavida ucu için uygun girintiyi kullanarak tornavida yardımı ile alt kapağı üst kapaktan ayırın, üst kapağı (2) çekerek çıkartın. Ürüne kablo montajı için (4) uygun

olan belirlenmiş kablo çıkış kanallarını üründen ayırarak kablo montajı için uygun hale getirin.

Ürünün duvara montajı için açılmış kanallardan (5) vida ile duvara montajını gerçekleştirin.

Modülü (3) uygun şekilde montaj yaptıktan sonra, üst kapağı (2) geçmeli kanallardan tutturmak suretiyle kapatarak, en son ürünün anahtar düğme ya da priz kapağını (1) yerine takarak montajı tamamlayın.



Palmiye  
nemli yer serisi  
IP54

Tozlu ve nemli mekanların ayrıcalığı







## Palmiye nemli yer serisi IP54



### Ana Renkler



Beyaz



Krem



Gri

Daha fazla dikkat ve özen isteyen alanlar şimdi IP 54 özellikli Palmiye serisinin ayrıcalığını yaşıyor. Nemli ve tozlu mekanlarda Palmiye serisi güvenlik duygusunun çitasını yükseltiyor. Yatay ve dikey olarak kombine edilebilen Palmiye serisi ürünleri uzun ömür ve dayanıklılık özelliğiyle öne çıkarken, krem ve gri renk seçenekleri dekoratif olarak tercih yapma olanağı sağlıyor.

## Renk Seçenekleri

### Beyaz



### Krem



### Gri



## Ürün Ölçüleri

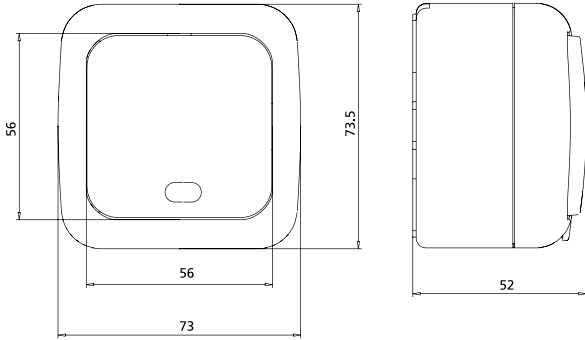

Palmye serisi bütün ürünler için beyaz, gri ve krem renk seçenekleri sunmaktadır.

### Palmye serisini farklı yapan üstün özellikler

- IP 54 özelliği sayesinde toza ve neme karşı dayanıklılık ve uzun ömürlü.
- Kapak, sadece vidayı çevirerek sökmeden monte ve demonte edilir.
- Kabloyu bastırarak monte etme imkanı sağlayan esnek conta sistemi.
- Hızlı bağlantı sistemiyle çabuk ve emniyetli kablolama.



**Anahtar**  
9055XX01



**Işıklı Anahtar**  
9055XX19



**Light Anahtar**  
9055XX03



**Işıklı Light Anahtar**  
9055XX14



**Kapı Otomatığı**  
9055XX05



**Zil Anahtar**  
9055XX06



**Işıklı Etiketli Zil Anahtar**  
9055XX27



**Permütör (Ara Veavien)**  
9055XX31



**Veavien**  
9055XX04



**Işıklı Veavien**  
9055XX63



**Komütatör Veavien**  
9055XX17



**Komütatör**  
9055XX02



**Topraklı Priz**  
9055XX08



**UPS Topraklı Priz**  
9055XX15



**TV Priz**  
9055XX10 (Sonlu)  
9055XX60 (Geçişli)  
9055XX49 (Direncsiz)



**Nümeris Telefon Prizi (RJ11)**  
9055XX13

## Yatay Kombinasyon



**Anahtar - Topraklı Priz**  
9055XX81



**Işıklı Anahtar - Topraklı Priz**  
9055XX99



**Light - Topraklı Priz**  
9055XX83



**Işıklı Light - Topraklı Priz**  
9055XX94



**Veavien - Topraklı Priz**  
9055XX84



**Işıklı Veavien - Topraklı Priz**  
9055XX93



**Komütatör Veavien - Topraklı Priz**  
9055XX87



**Komütatör - Topraklı Priz**  
9055XX82



**Topraklı Priz - Topraklı Priz**  
9055XX88

## Dikey Kombinasyon



**Anahtar - Topraklı Priz**  
9055YY81



**İşikli Anahtar - Topraklı Priz**  
9055YY94



**İşikli Veavien - Topraklı Priz**  
9055YY92



**Veavien - Topraklı Priz**  
9055YY89



**İşikli Light - UPS Topraklı Priz**  
9055YY97



**Light - Topraklı Priz**  
9055YY83



**Komütatör Veavien - Topraklı Priz**  
9055YY90



**Komütatör - Topraklı Priz**  
9055YY82



**Topraklı Priz - Topraklı Priz**  
9055YY91

## İsteğinize Uygun Yatay ve Dikey İkili Kombine Seçenekleri!

Dilediğiniz ürünleri seçerek ihtiyaçlarınıza uygun yeni kombinasyonlar oluşturabilirsiniz.







Sigorta  
Kutuları



## Sigorta Kutuları



Bugün hemen her noktada aynı anda talep edilen iki kavram, güvenlik ve tasarım, VIKO sigorta kutularında bulundu. Plastiğin yalıtıncılığıyla hassas güvenlik, estetik hatlarıyla dekoratif duruş VIKO sigorta kutularında bir arada ve hayatın içinde. Diğer yandan dayanıklı yapısıyla ısıya ve darbelere karşı direnç gösteren sigorta kutuları, geniş iç hacmiyle de çalışma rahatlığı beklentilerini en iyi şekilde karşılıyor.

### Ürün Özellikleri

VIKO sigorta kutuları; plastiğin yalıtıncılığıyla güvenlik, seçkin tasarımıyla da estetik bir görünüm sağlıyor. Isıya ve darbeye karşı dayanıklı yapısı ve çalışma rahatlığı sağlayan geniş iç hacmi sayesinde de beklentilerinizi fazlasıyla karşılıyor.

- IP40 Koruma standardına uygundur.
- Sınıf II; elektrik çarpmasına karşı korumalıdır.
- Tesis sırasındaki sıcaklık aralığı -15°C / + 60°C.
- 650°C'ye kadar alev ve yanmaya karşı dayanıklıdır.
- Kullanım yerine göre 180°C çevrilerek takılabilen kapaklara sahiptir.
- Çerçevenin yaylı olması cam kapağının açık kalmasını sağlar.
- Sigorta rayı galvanizli sacdan imal edilmiştir.
- Geniş iç hacmi sayesinde montaj ve çalışma rahatlığı sağlar.
- Isıya ve darbelere karşı dayanıklıdır.
- Topraklama klemensi ve bağlantı aksesuarları mevcuttur.
- Yalıtımı topraklamayla bağlama opsiyonu.
- Halojensiz opsiyonu.
- Montaj hassasiyeti sağlayan su terazisi.



IP 40



## Klemens



4'li Klemens  
90910001



6'li Klemens  
90910002



9'lu Klemens  
90910003



10'lu Klemens  
90910004



12'li Klemens  
90910005



6'li İzole Klemens  
90911002



10'lu İzole Klemens  
90911005



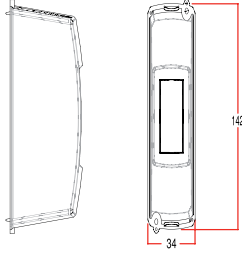
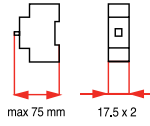

**1'li Sıva Üstü**  
90914000



**1-2'li Sıva Üstü**  
90914001

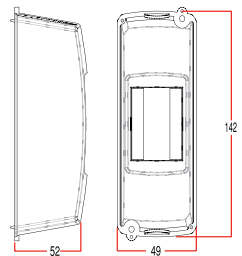
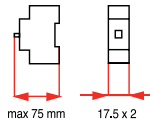

**3-4'lü Sıva Üstü**  
90914003



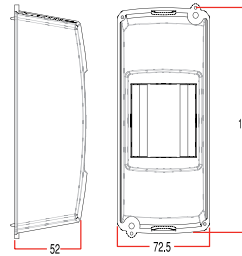
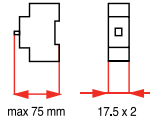

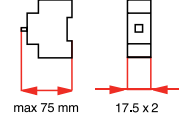
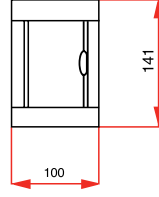
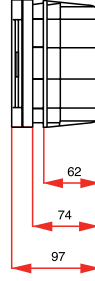

2'li Sıva Altı  
90912002

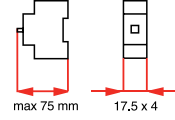
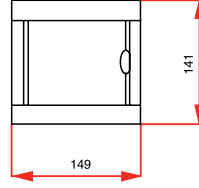
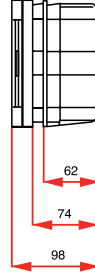

4'lü Sıva Altı  
90912004



6'lı Sıva Altı  
90912006

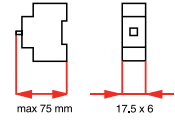
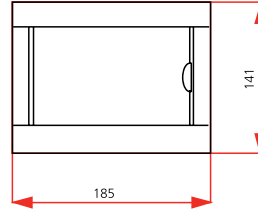
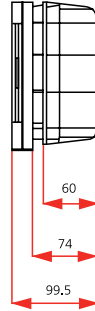

8'li Sıva Altı  
90912008



Kilitli kapak sistemi.

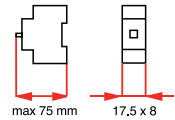
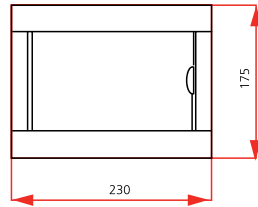

12'li Sıva Altı  
90912012



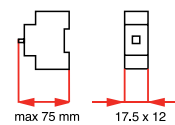
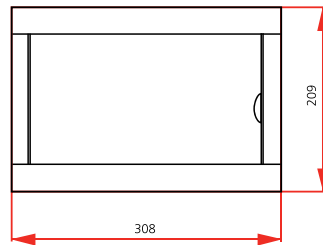
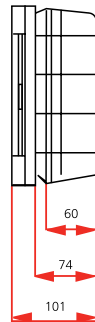

Kilitli kapak sistemi.









**16'lı Sıva Altı**  
90912016

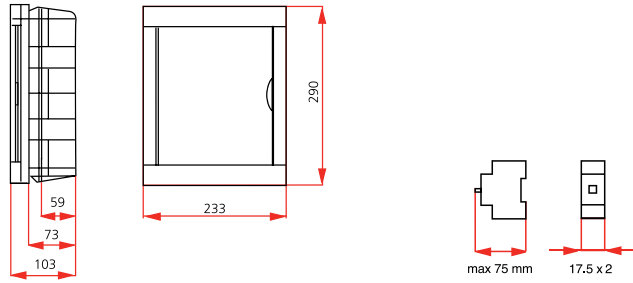

Kilitli kapak sistemi.





**18'li Sıva Altı**  
90912018

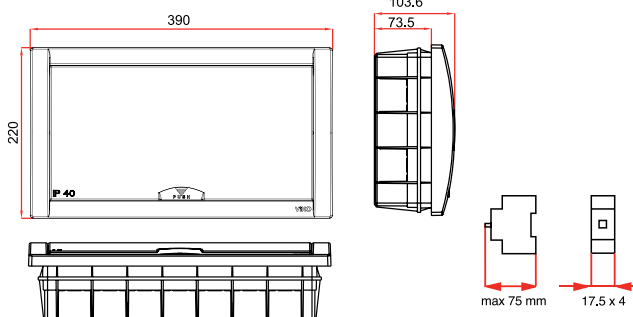

Kilitli kapak sistemi.





**24'lü Sıva Altı**  
90912024

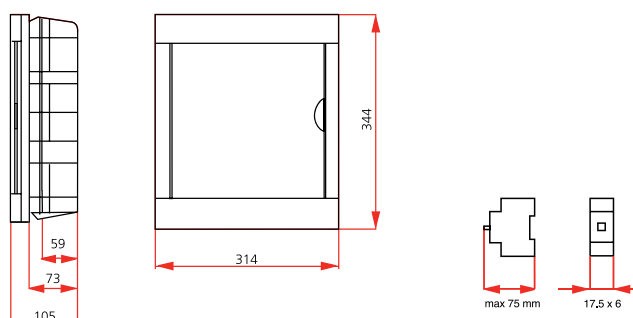

Kilitli kapak sistemi.



**36'lı Sıva Altı**  
90912036



Kilitli kapak sistemi.

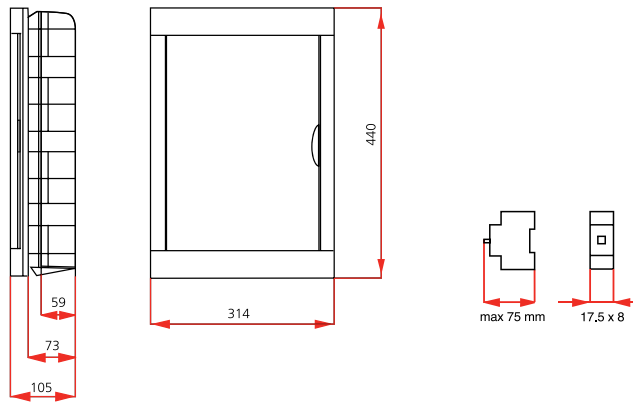





2'li Sıva Üstü  
90912102

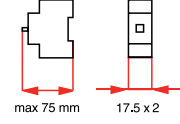
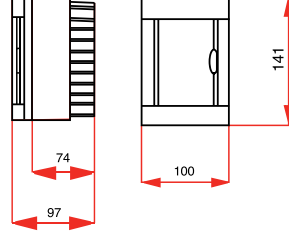

4'lü Sıva Üstü  
90912104

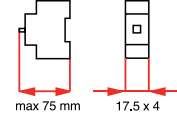
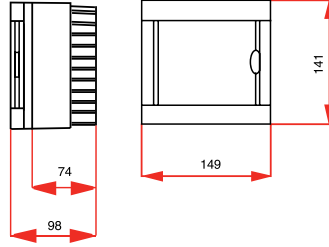

6'lı Sıva Üstü  
90912106

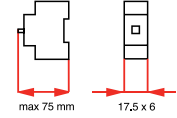
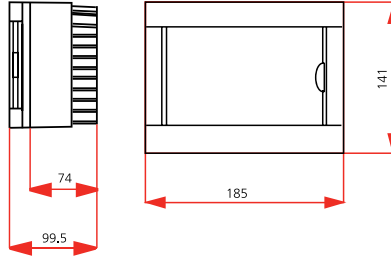

8'li Sıva Üstü  
90912108



Kilitli kapak sistemi.

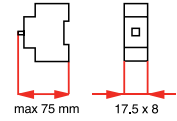
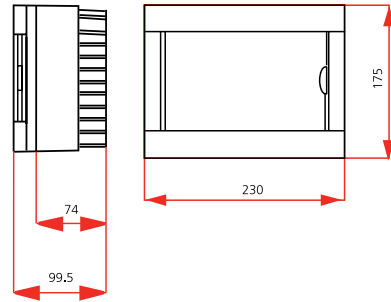



12'li Sıva Üstü  
90912112

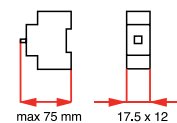
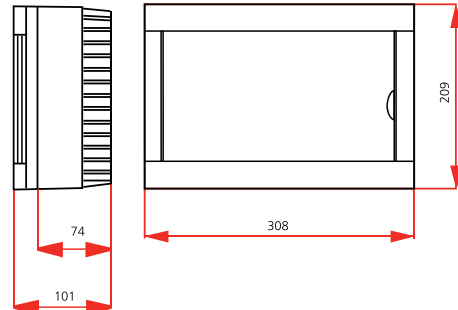

Kilitli kapak sistemi.





**16'lı Sıva Üstü**  
90912116

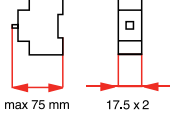
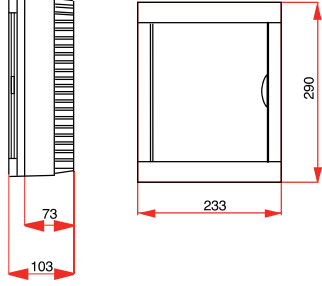

Kilitli kapak sistemi.





**18'li Sıva Üstü**  
90912118

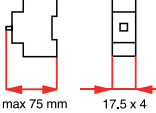
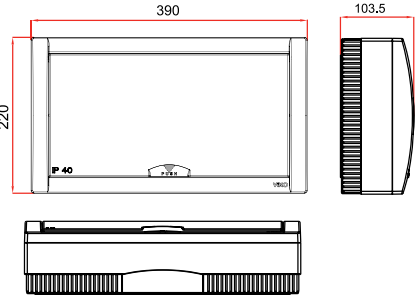

Kilitli kapak sistemi.





**24'lü Sıva Üstü**  
90912124

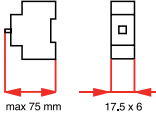
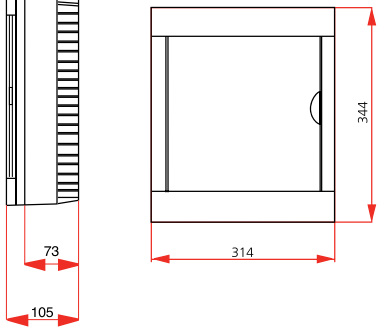

Kilitli kapak sistemi.



**36'lı Sıva Üstü**  
90912136



Kilitli kapak sistemi.

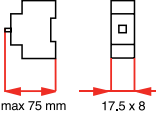
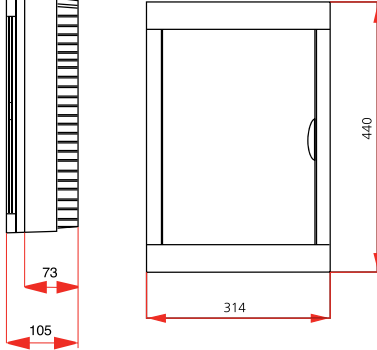



Grup Priz ve  
Aksesuarlar  
IP40







## Grup Priz ve Aksesuarlar IP40



Leylak



Beyaz



Siyah

Lale



Beyaz

İhtiyaçların sınırsız olduğu ve ancak esnek çözümlerle memnuniyete ulaşılan bir dönemde yaşıyoruz. VİKO grup prizler ve aksesuarlar işte bu anlayışla tasarlanıp üretiliyor. Dayanıklı gövdeleri ve kaliteli iç yapılarıyla her VİKO ürünü yaşam alanlarıyla bütünleşiyor.

## İkili Topraklı Priz



**Klemensli**  
90207700 90207750 (Siyah)



**Kablolu**  
90107600 (2 m) 90107646 (2 m) (Siyah)  
90107603 (3 m) 90107643 (3 m) (Siyah)  
90107605 (5 m) 90107645 (5 m) (Siyah)



**Anahtarlı Klemensli**  
90207720 90207752 (Siyah)



**Anahtarlı Kablolu**  
90107620 (2 m) 90107656 (2 m) (Siyah)  
90107623 (3 m) 90107653 (3 m) (Siyah)  
90107625 (5 m) 90107655 (5 m) (Siyah)



**Klemensli-UPS**  
90207704 90207751 (Siyah)



**Kablolu-UPS**  
90107604 (2 m) 90107644 (2 m) (Siyah)



**Anahtarlı Klemensli-UPS**  
90207724 90207753 (Siyah)



**Anahtarlı Kablolu-UPS**  
90107624 (2 m) 90107638 (2 m) (Siyah)

## Üçlü Topraklı Priz



**Klemensli**  
90207900 90207946 (Siyah)



**Kablolu**  
90107800 (2 m) 90107846 (2 m) (Siyah)  
90107803 (3 m) 90107843 (3 m) (Siyah)  
90107805 (5 m) 90107845 (5 m) (Siyah)



**Anahtarlı Klemensli**  
90207920 90207956 (Siyah)



**Anahtarlı Kablolu**  
90107820 (2 m) 90107856 (2 m) (Siyah)  
90107823 (3 m) 90107853 (3 m) (Siyah)  
90107825 (5 m) 90107855 (5 m) (Siyah)



**Klemensli-UPS**  
90207904 90207951 (Siyah)



**Kablolu-UPS**  
90107804 (2 m) 90107844 (2 m) (Siyah)



**Anahtarlı Klemensli-UPS**  
90207924 90207953 (Siyah)



**Anahtarlı Kablolu-UPS**  
90107824 (2 m) 90107837 (2 m) (Siyah)

## Dörtlü Topraklı Priz



**Klemensli**  
90208100 90208150 (Siyah)



**Anahtarlı Klemensli**  
90208120 90208152 (Siyah)



**Kablolu**  
90108000 (2 m) 90108046 (2 m) (Siyah)  
90108003 (3 m) 90108043 (3 m) (Siyah)  
90108005 (5 m) 90108045 (5 m) (Siyah)



**Anahtarlı Kablolu**  
90108020 (2 m) 90108056 (2 m) (Siyah)  
90108023 (3 m) 90108053 (3 m) (Siyah)  
90108025 (5 m) 90108055 (5 m) (Siyah)



**Klemensli-UPS**  
90208104 90208151 (Siyah)



**Anahtarlı Klemensli-UPS**  
90208124 90208153 (Siyah)



**Kablolu-UPS**  
90108004 (2 m) 90108044 (2 m) (Siyah)



**Anahtarlı Kablolu-UPS**  
90108024 (2 m) 90108038 (2 m) (Siyah)



## Beşli Topraklı Priz



**Klemensli**  
90208500 90208550 (Siyah)



**Anahtarlı Klemensli**  
90208520 90208537 (Siyah)



**Kablolu**  
90108400 (2 m) 90108446 (2 m) (Siyah)  
90108403 (3 m) 90108443 (3 m) (Siyah)  
90108405 (5 m) 90108445 (5 m) (Siyah)



**Anahtarlı Kablolu**  
90108420 (2 m) 90108456 (2 m) (Siyah)  
90108423 (3 m) 90108453 (3 m) (Siyah)  
90108425 (5 m) 90108455 (5 m) (Siyah)



**Klemensli-UPS**  
90208504 90208551 (Siyah)



**Anahtarlı Klemensli-UPS**  
90208524 90208553 (Siyah)



**Kablolu-UPS**  
90108404 (2 m) 90108444 (2 m) (Siyah)



**Anahtarlı Kablolu-UPS**  
90108424 (2 m) 90108438 (2 m) (Siyah)

## Altılı Topraklı Priz



**Klemensli**  
90208300 90208346 (Siyah)



**Anahtarlı Klemensli**  
90208320 90208352 (Siyah)



**Kablolu**  
90108200 (2 m) 90108246 (2 m) (Siyah)  
90108203 (3 m) 90108243 (3 m) (Siyah)  
90108205 (5 m) 90108245 (5 m) (Siyah)



**Anahtarlı Kablolu**  
90108220 (2 m) 90108256 (2 m) (Siyah)  
90108223 (3 m) 90108253 (3 m) (Siyah)  
90108225 (5 m) 90108255 (5 m) (Siyah)

## Altılı Topraklı Priz



**Klemensli-UPS**  
90208304 90208351 (Siyah)



**Anahtarlı Klemensli-UPS**  
90208324 90208353 (Siyah)



**Kablolu-UPS**  
90108204 (2 m) 90108244 (2 m) (Siyah)



**Anahtarlı Kablolu-UPS**  
90108224 (2 m) 90108238 (2 m) (Siyah)

## Topraksız Priz



**Klemensli**  
90208700 90208702 (Siyah)



**Klemensli**  
90208900 90208902 (Siyah)



**Kablolu**  
90108600 (2 m) 90108630 (2 m) (Siyah)  
90108603 (3 m) 90108631 (3 m) (Siyah)  
90108605 (5 m) 90108632 (5 m) (Siyah)



**Kablolu**  
90108800 (2 m) 90108830 (2 m) (Siyah)  
90108803 (3 m) 90108831 (3 m) (Siyah)  
90108805 (5 m) 90108832 (5 m) (Siyah)



**Klemensli**  
90209100 90209102 (Siyah)



**Anahtarlı Klemensli**  
90208920 90208922 (Siyah)



**Kablolu**  
90109000 (2 m) 90109020 (2 m) (Siyah)  
90109003 (3 m) 90109031 (3 m) (Siyah)  
90109005 (5 m) 90109032 (5 m) (Siyah)



**Anahtarlı Kablolu**  
90108820 (2 m) 90108833 (2 m) (Siyah)  
90108823 (3 m) 90108834 (3 m) (Siyah)  
90108825 (5 m) 90108835 (5 m) (Siyah)





## Üçlü Topraklı Priz



**Klemensli**  
90205700



**Kablolu**  
90105600 (2 m)  
90105603 (3 m)  
90105605 (5 m)



**Anahtarlı Klemensli**  
90205720



**Anahtarlı Kablolu**  
90105620 (2 m)  
90105623 (3 m)  
90105625 (5 m)



**Klemensli-UPS**  
90205704



**Kablolu-UPS**  
90105604 (2 m)



**Anahtarlı Klemensli-UPS**  
90205724



**Anahtarlı Kablolu-UPS**  
90105624 (2 m)

## Altılı Topraklı Priz



**Klemensli**  
90205900



**Kablolu**  
90105800 (2 m)  
90105803 (3 m)  
90105805 (5 m)



**Klemensli-UPS**  
90205904



**Kablolu-UPS**  
90105804 (2 m)



**Anahtarlı Klemensli**  
90205920



**Anahtarlı Kablolu**  
90105820 (2 m)  
90105823 (3 m)  
90105825 (5 m)



**Anahtarlı Klemensli-UPS**  
90205924



**Anahtarlı Kablolu-UPS**  
90105824 (2 m)

## Aksesuarlar



**Yonca Sıva Altı Topraklı Üçlü Priz**  
90304000



**Yonca Topraklı Üçlü Priz-Fiş**  
90303000



**Siyah Yonca Topraklı Üçlü Priz-Fiş**  
90303300



**Topraklı Dişi Fiş**  
90301800



**Monofaze Dişi Fiş**  
90302500



**Telefon Fişi**  
90302800



**Topraklı Ütü Fişi**  
90302000



**Ütü Fişi**  
90301900



**Monoblok Topraklı Erkek Fiş**  
90304200



**Topraklı Erkek Fiş**  
90304100



**Monoblok UPS Topraklı Erkek Fiş**  
90304240



**Mimoza Erkek Fiş**  
90305400



**Mimoza Erkek Fiş Siyah**  
90305410



**Bakalit Ara Puar**  
90302700



**Uzatıcı Takım**  
90302100 (3 m)  
90302200 (5 m)  
90302210 (10 m)



**Topraklı Uzatıcı Takım**  
90302300 (3 m)  
90302400 (5 m)  
90302410 (10 m)



**Alçıpan Kasa**  
9092600X



**Derin Geçmeli Kasa**  
90926001



**Kısa Geçmeli Kasa**  
90926002



**Norm Kasa**  
90926003

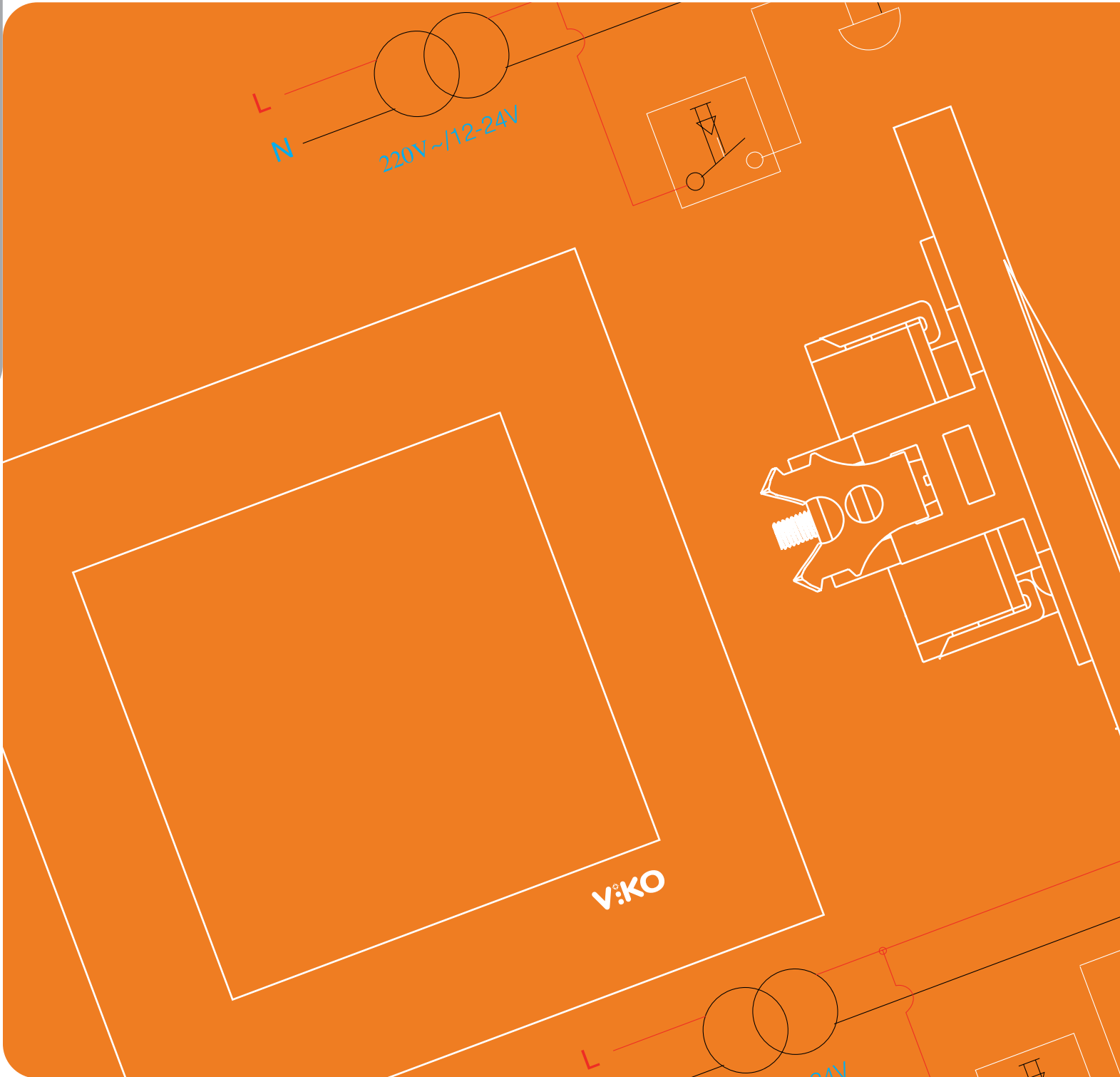



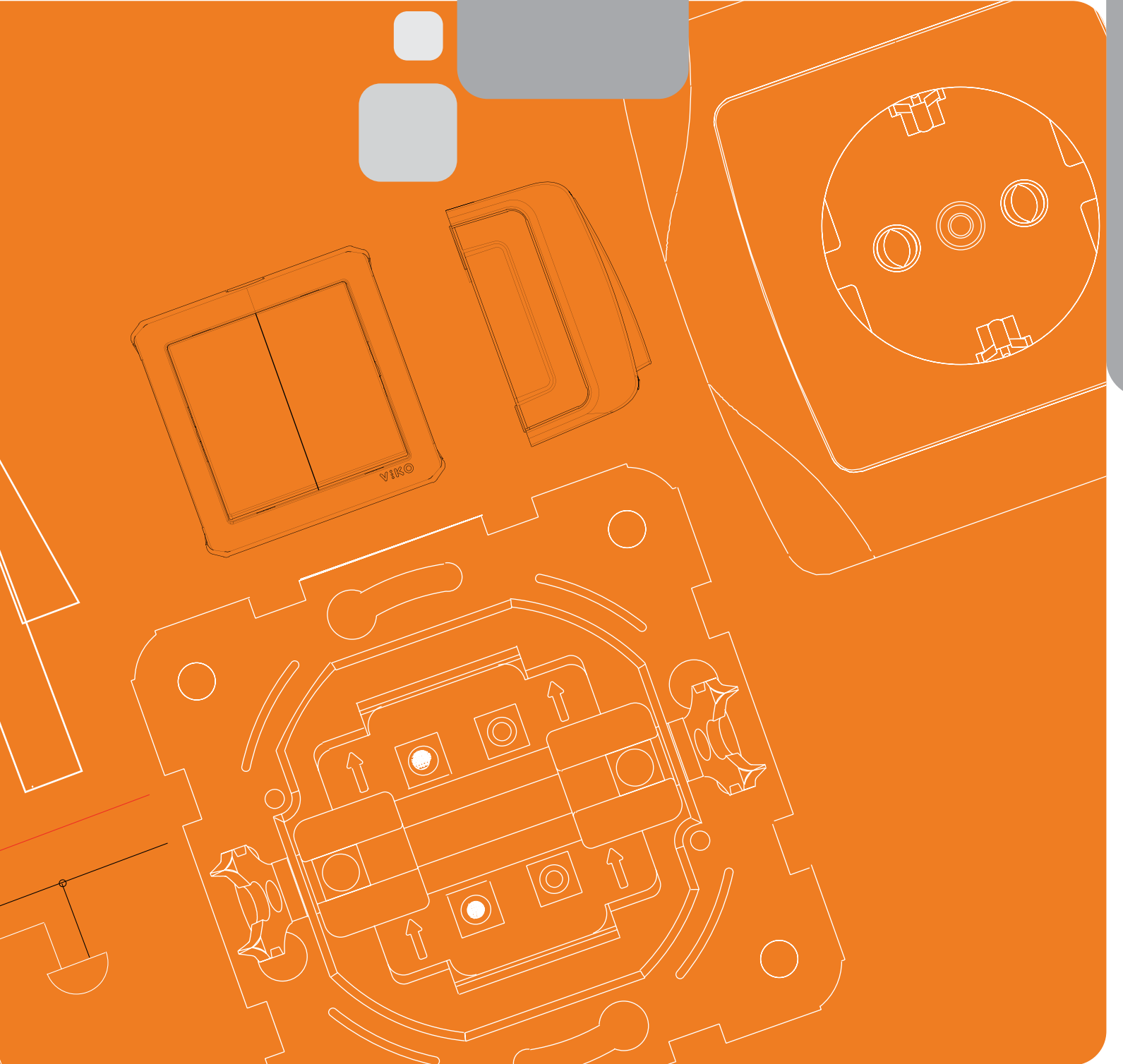





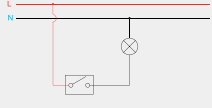
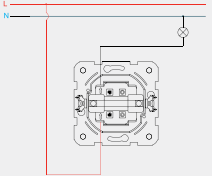

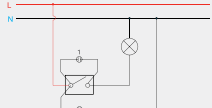
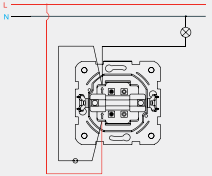
Teknik  
Özellikler

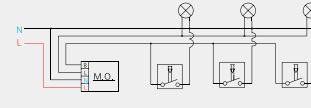
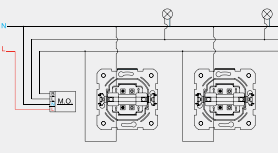

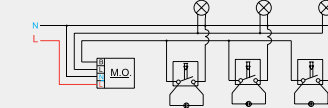
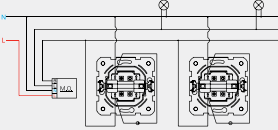

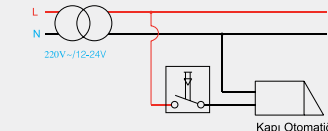
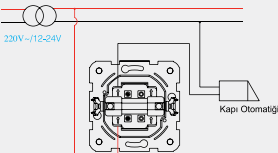

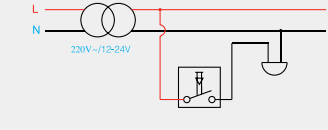
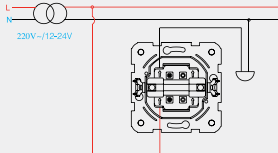

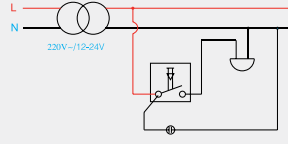
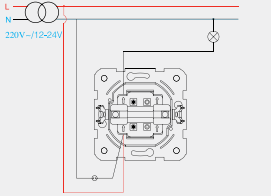
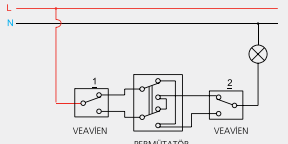
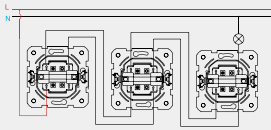
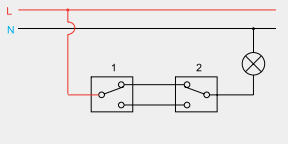
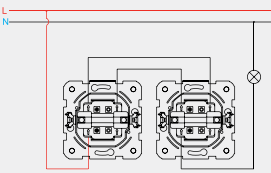
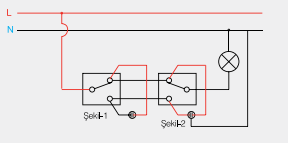
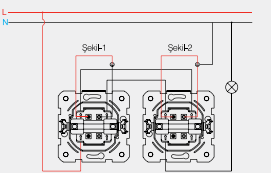
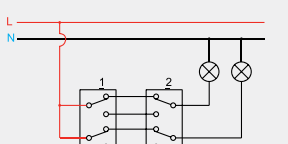
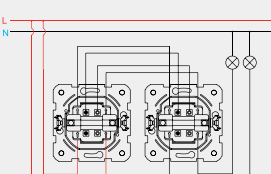









 <b>Anahtar</b>	<b>Teknik Özellikler</b> <ul style="list-style-type: none"><li>• Bir lamba veya lamba grubuna bir yerden kumanda eder.</li><li>• 10 AX, 250 V~</li><li>• Bir kutuplu, bir yollu.</li><li>• Vidalı veya vidasız (çabuk bağlantılı) montaj seçeneği.</li></ul>	<b>Devre şeması</b> 	<b>Bağlantı şeması</b> 
 <b>Işıklı Anahtar</b>	<b>Teknik Özellikler</b> <ul style="list-style-type: none"><li>• Bir lamba veya lamba grubuna bir yerden kumanda eder.</li><li>• 10 AX, 250 V~</li><li>• Bir kutuplu, bir yollu.</li><li>• Işıklı.</li><li>• Vidalı veya vidasız (çabuk bağlantılı) montaj seçeneği.</li><li>• Neon lamba akımı 0,6 - 1mA.</li></ul>	<b>Devre şeması</b>  <small>1 - Akkor filamanlı (tungsten) lamba için kullanılır 2 - Balast veya trafo içeren aydınlatma ürünleri, tasarruf ampulleri için kullanılır.</small>	<b>Bağlantı şeması</b> 
 <b>Light Anahtarı</b>	<b>Teknik Özellikler</b> <ul style="list-style-type: none"><li>• Bir lamba veya lamba grubuna kumanda eden merdiven otomatığının harekete geçirilmesinde kullanılır.</li><li>• 10 A, 250 V~</li><li>• Bir kutuplu, bir yollu.</li><li>• Ani basmalı tip.</li><li>• Vidalı veya vidasız (çabuk bağlantılı) montaj seçeneği.</li></ul>	<b>Devre şeması</b> 	<b>Bağlantı şeması</b> 
 <b>Işıklı Light Anahtarı</b>	<b>Teknik Özellikler</b> <ul style="list-style-type: none"><li>• Bir lamba veya lamba grubuna kumanda eden merdiven otomatığının harekete geçirilmesinde kullanılır.</li><li>• 10 A, 250 V~</li><li>• Bir kutuplu, bir yollu.</li><li>• Ani basmalı tip.</li><li>• Işıklı.</li><li>• Vidalı veya vidasız (çabuk bağlantılı) montaj seçeneği.</li><li>• Neon lamba akımı 0,6 - 1mA.</li></ul>	<b>Devre şeması</b> 	<b>Bağlantı şeması</b> 
 <b>Kapı Otomatığı Anahtarı</b>	<b>Teknik Özellikler</b> <ul style="list-style-type: none"><li>• Kapı otomatığını kumanda eder.</li><li>• 10 A, 250 V~</li><li>• Bir kutuplu, bir yollu.</li><li>• Ani basmalı tip.</li><li>• Vidalı veya vidasız (çabuk bağlantılı) montaj seçeneği.</li></ul>	<b>Devre şeması</b> 	<b>Bağlantı şeması</b> 
 <b>Zil Anahtarı</b>	<b>Teknik Özellikler</b> <ul style="list-style-type: none"><li>• Kapı zilini kumanda eder.</li><li>• 10 A, 250 V~</li><li>• Bir kutuplu, bir yollu.</li><li>• Ani basmalı tip.</li><li>• Vidalı veya vidasız (çabuk bağlantılı) montaj seçeneği.</li></ul>	<b>Devre şeması</b> 	<b>Bağlantı şeması</b> 



<p><b>İşıkli Etiketli Zil Anahtarı</b></p>	<p><b>Teknik Özellikler</b></p> <ul style="list-style-type: none"> <li>• Kapı zilini kumanda eder.</li> <li>• 10 A, 250 V~</li> <li>• Bir kutuplu, bir yollu.</li> <li>• Ani basmalı tip.</li> <li>• İşıkli ve etiketli.</li> <li>• Vidalı veya vidasız (çabuk bağlantılı) montaj seçeneği.</li> <li>• Neon lamba akımı 0,6 - 1mA.</li> </ul>	<p><b>Devre şeması</b></p> 	<p><b>Bağlantı şeması</b></p> 
<p><b>Permütatör (Ara Veavien)</b></p>	<p><b>Teknik Özellikler</b></p> <ul style="list-style-type: none"> <li>• Permütatör, bir lamba veya lamba grubuna, ikiden fazla yerden kumanda edilmesini sağlar.</li> <li>• 10 A, 250 V~</li> <li>• Bir kutuplu, iki yollu.</li> <li>• Vidalı veya vidasız (çabuk bağlantılı) montaj seçeneği.</li> </ul>	<p><b>Devre şeması</b></p> 	<p><b>Bağlantı şeması</b></p> 
<p><b>Veavien</b></p>	<p><b>Teknik Özellikler</b></p> <ul style="list-style-type: none"> <li>• Bir lamba veya lamba grubunu iki ayrı noktadan kumanda eder.</li> <li>• 10 AX, 250 V~</li> <li>• Bir kutuplu, iki yollu.</li> <li>• Vidalı veya vidasız (çabuk bağlantılı) montaj seçeneği.</li> </ul>	<p><b>Devre şeması</b></p> 	<p><b>Bağlantı şeması</b></p> 
<p><b>İşıkli Veavien</b></p>	<p><b>Teknik Özellikler</b></p> <ul style="list-style-type: none"> <li>• Bir lamba veya lamba grubunu iki ayrı noktadan kumanda eder.</li> <li>• 10 AX, 250 V~</li> <li>• Bir kutuplu, iki yollu.</li> <li>• İşıkli.</li> <li>• Vidalı veya vidasız (çabuk bağlantılı) montaj seçeneği.</li> <li>• Neon lamba akımı 0,6 - 1mA.</li> <li>• Kullanılan neonun üç bacağı olup, tungsten ampul ile birlikte kullanılırken kırmızı uçlardan biri veavien çıkışının birine siyah uç diğer çıkışa bağlanır. (Şekil-1)</li> <li>• Floresan lamba ile kullanımda neonun kırmızı uçlarından biri veavienin bir çıkışına diğer kırmızı uçta diğer çıkışa bağlanır, siyah olan uç ise nötre bağlanır. (Şekil-2)</li> </ul>	<p><b>Devre şeması</b></p> 	<p><b>Bağlantı şeması</b></p> 
<p><b>Komütatör Veavien</b></p>	<p><b>Teknik Özellikler</b></p> <ul style="list-style-type: none"> <li>• İki ayrı lamba veya lamba grubuna aynı yerden kumanda eder.</li> <li>• 10 AX, 250 V~</li> <li>• İki kutuplu, iki yollu.</li> <li>• Vidalı veya vidasız (çabuk bağlantılı) montaj seçeneği.</li> </ul>	<p><b>Devre şeması</b></p> 	<p><b>Bağlantı şeması</b></p> 



 <b>Komütatör</b>	<b>Teknik Özellikler</b> <ul style="list-style-type: none"><li>• İki ayrı lamba veya lamba grubuna aynı yerden kumanda eder.</li><li>• 10 AX, 250 V~</li><li>• Bir kutuplu, iki yollu.</li><li>• Vidalı veya vidasız (çabuk bağlantılı) montaj seçeneği.</li></ul>	<b>Devre şeması</b>	<b>Bağlantı şeması</b>												
 <b>İşikli Komütatör</b>	<b>Teknik Özellikler</b> <ul style="list-style-type: none"><li>• İki ayrı lamba veya lamba grubuna aynı yerden kumanda eder.</li><li>• 10 AX, 250 V~</li><li>• Bir kutuplu, iki yollu.</li><li>• İşikli.</li><li>• Vidalı veya vidasız (çabuk bağlantılı) montaj seçeneği.</li><li>• Neon lamba akımı 0,6 - 1mA.</li></ul>	<b>Devre şeması</b>	<b>Bağlantı şeması</b>												
 <b>Üçlü Anahtar</b>	<b>Teknik Özellikler</b> <ul style="list-style-type: none"><li>• Üç ayrı lamba veya lamba grubunu aynı yerden kumanda eder.</li><li>• 10 AX, 250 V~</li><li>• Bir kutuplu, üç yollu.</li><li>• Vidalı veya vidasız (çabuk bağlantılı) montaj seçeneği.</li></ul>	<b>Devre şeması</b>	<b>Bağlantı şeması</b>												
 <b>Tek Düğmeli Jaluzi Kumanda Anahtarı</b>	<b>Teknik Özellikler</b> <ul style="list-style-type: none"><li>• Jaluzi motorlarının devir yönünü değiştirerek, jaluzinin yukarı ve aşağı yönde hareketini kumanda eder.</li><li>• 10 A, 250 V~</li><li>• Bir kutuplu, iki yollu.</li><li>• Çabuk bağlantı (vidasız) klemensli.</li></ul>	<b>Devre şeması</b>	<b>Bağlantı şeması</b>												
 <b>Jaluzi Kumanda Anahtarı</b>	<b>Teknik Özellikler</b> <ul style="list-style-type: none"><li>• Jaluzi motorlarının devir yönünü değiştirerek, jaluzinin yukarı ve aşağı yönde hareketini kumanda eder.</li><li>• 10 A, 250 V~</li><li>• Bir kutuplu, iki yollu.</li><li>• Vidalı veya vidasız (çabuk bağlantılı) montaj seçeneği.</li></ul>	<b>Devre şeması</b>	<b>Bağlantı şeması</b>												
 <b>Rotatif Dimmer 600 W RL</b>	<table border="1"><thead><tr><th></th><th>220 V~ 50-60 Hz</th><th>Min.</th><th>Max.</th></tr></thead><tbody><tr><td> Akkor İlamankı ve Hubuk halojen lamba</td><td></td><td>60 W</td><td>600 W</td></tr><tr><td> Mekanik trafolu halojen lamba</td><td></td><td>100 W</td><td>450 W</td></tr></tbody></table>		220 V~ 50-60 Hz	Min.	Max.	 Akkor İlamankı ve Hubuk halojen lamba		60 W	600 W	 Mekanik trafolu halojen lamba		100 W	450 W	<b>Devre şeması</b>	<b>Bağlantı şeması</b>
	220 V~ 50-60 Hz	Min.	Max.												
 Akkor İlamankı ve Hubuk halojen lamba		60 W	600 W												
 Mekanik trafolu halojen lamba		100 W	450 W												

**Rotatif Dimmer  
1000 W RL**

**Teknik Özellikler**

	220 V~ 50-60 Hz	Min.	Max.
 Akkor flamanlı ve çubuk halojen lamba		100 W	1000 W
 Mekanik trafolu halojen lamba		100 W	800 W

**Devre şeması**

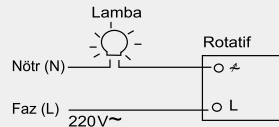

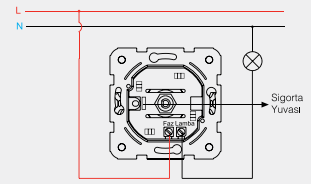

**Bağlantı şeması**



**Rotatif Dimmer  
400 W RC**

**Teknik Özellikler**

	220 V~ 50-60 Hz	Min.	Max.
 Akkor flamanlı ve çubuk halojen lamba		60 W	400 W
 Elektronik trafolu halojen lamba		60 W	400 W

**Devre şeması**

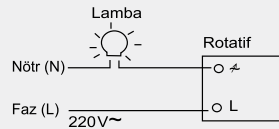

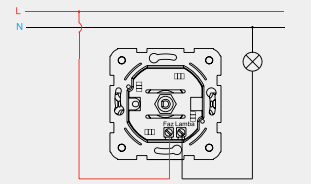

**Bağlantı şeması**



**Dokunmatik Dimmer RL**

**Teknik Özellikler**

	220 V~ 50-60 Hz	Min.	Max.
 Akkor flamanlı ve çubuk halojen lamba		60 W	500 W
 Mekanik trafolu halojen lamba		100 W	400 W

**Devre şeması**

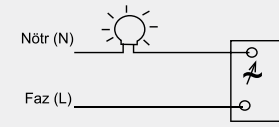

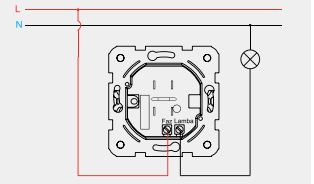

**Bağlantı şeması**



**Veavien Dimmer RL**

**Teknik Özellikler**

	220 V~ 50-60 Hz	Min.	Max.
 Akkor flamanlı ve çubuk halojen lamba		60 W	500 W
 Mekanik trafolu halojen lamba		100 W	400 W

**Devre şeması**

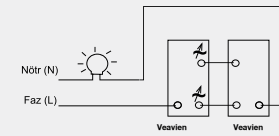

**Bağlantı şeması**

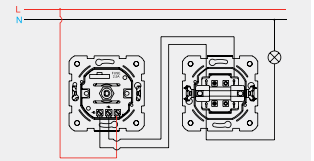

**Müzik Yayın Anahtarı**

**Teknik Özellikler**

- 11 kademeli ses ayarı.
- 8 Ω ohmik dirençli ses ayarı.
- 5 W hoparlör girişi.

**Devre şeması**

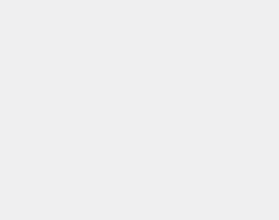

**Bağlantı şeması**

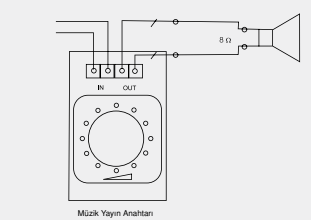

**Trafolu Müzik Yayın Anahtarı**

**Teknik Özellikler**

- 11 kademeli ses ayarı.
- 100 V ses sistemleri için.
- 2 VA trafolu
- 4 x 100V hoparlör desteği.

**Devre şeması**

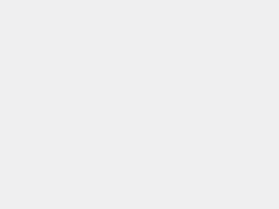



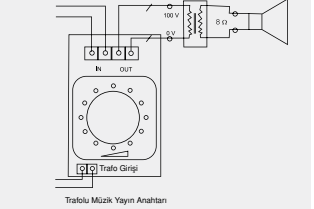







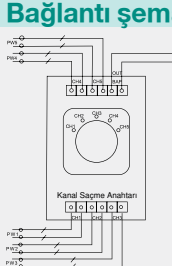

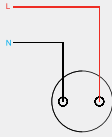
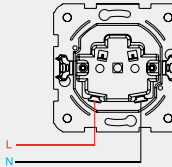

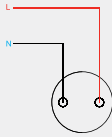
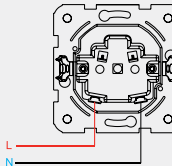

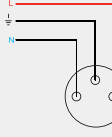
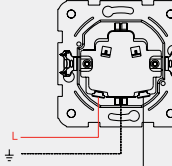

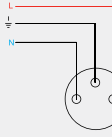
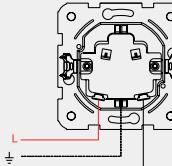

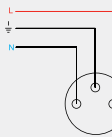
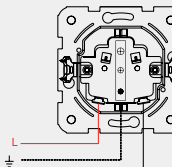

**Bağlantı şeması**

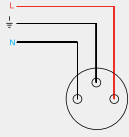
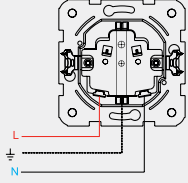

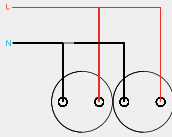
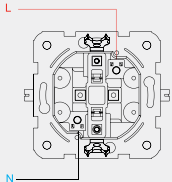

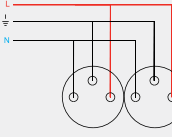
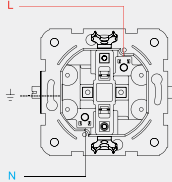

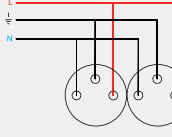
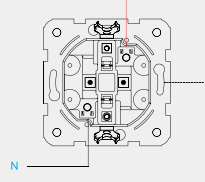

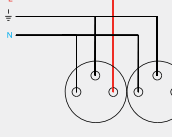
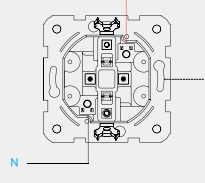



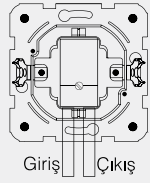
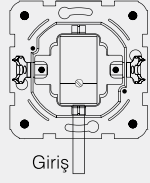
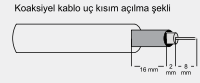

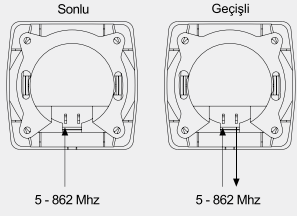

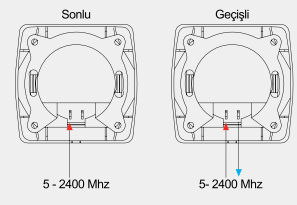

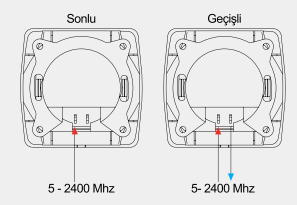

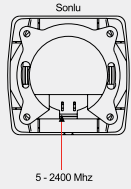

 <b>Kanal Seçme Anahtarı</b>	<b>Teknik Özellikler</b> <ul style="list-style-type: none"><li>• 5 kanal seçme özelliği.</li><li>• 100V ve 8 Ω sistemler için kullanıma uygun.</li><li>• Vidalı tip bağlantılı.</li></ul>	<b>Devre şeması</b> 	<b>Bağlantı şeması</b> 
 <b>Priz</b>	<b>Teknik Özellikler</b> <ul style="list-style-type: none"><li>• 16 A, 250 V~</li><li>• İki kutuplu.</li><li>• Vidalı veya vidasız (çabuk bağlantılı) montaj seçeneği.</li></ul>	<b>Devre şeması</b> 	<b>Bağlantı şeması</b> 
 <b>Çocuk Korumalı Priz</b>	<b>Teknik Özellikler</b> <ul style="list-style-type: none"><li>• 16 A, 250 V~</li><li>• İki kutuplu.</li><li>• Vidalı veya vidasız (çabuk bağlantılı) montaj seçeneği.</li></ul>	<b>Devre şeması</b> 	<b>Bağlantı şeması</b> 
 <b>Topraklı Priz</b>	<b>Teknik Özellikler</b> <ul style="list-style-type: none"><li>• 16 A, 250 V~</li><li>• İki kutuplu ve topraklama kontaklı.</li><li>• Vidalı veya vidasız (çabuk bağlantılı) montaj seçeneği.</li></ul>	<b>Devre şeması</b> 	<b>Bağlantı şeması</b> 
 <b>Çocuk Korumalı Topraklı Priz</b>	<b>Teknik Özellikler</b> <ul style="list-style-type: none"><li>• 16 A, 250 V~</li><li>• İki kutuplu ve topraklama kontaklı.</li><li>• Vidalı veya vidasız (çabuk bağlantılı) montaj seçeneği.</li></ul>	<b>Devre şeması</b> 	<b>Bağlantı şeması</b> 
 <b>Çocuk Korumalı UPS Topraklı Priz</b>	<b>Teknik Özellikler</b> <ul style="list-style-type: none"><li>• 16 A, 250 V~</li><li>• İki kutuplu ve kontak çubuğu biçimli topraklama kontaklı.</li><li>• Vidalı veya vidasız (çabuk bağlantılı) montaj seçeneği.</li></ul>	<b>Devre şeması</b> 	<b>Bağlantı şeması</b> 

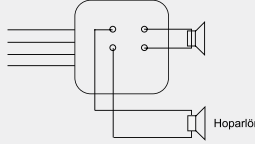
<p> <b>Kapaklı Topraklı Priz</b></p>	<p><b>Teknik Özellikler</b></p> <ul style="list-style-type: none"> <li>• 16 A, 250 V~</li> <li>• İki kutuplu ve topraklama kontaklı.</li> <li>• Vidalı veya vidasız (çabuk bağlantılı) montaj seçeneği.</li> </ul>	<p><b>Devre şeması</b></p> 	<p><b>Bağlantı şeması</b></p> 
<p> <b>İkili Priz</b></p>	<p><b>Teknik Özellikler</b></p> <ul style="list-style-type: none"> <li>• 16 A, 250 V ~</li> <li>• İki kutuplu.</li> <li>• Vidalı bağlantı.</li> </ul>	<p><b>Devre şeması</b></p> 	<p><b>Bağlantı şeması</b></p> 
<p> <b>İkili Topraklı Priz</b></p>	<p><b>Teknik Özellikler</b></p> <ul style="list-style-type: none"> <li>• Fitreli ve EMC uyumlu.</li> <li>• Sigortalı 2.5A (değiştirilebilir).</li> </ul>	<p><b>Devre şeması</b></p> 	<p><b>Bağlantı şeması</b></p> 
<p> <b>Çocuk Korumalı İkili UPS Topraklı Priz</b></p>	<p><b>Teknik Özellikler</b></p> <ul style="list-style-type: none"> <li>• 16 A, 250 V~</li> <li>• İki kutuplu ve kontak çubuğu biçimli topraklama kontaklı.</li> <li>• Vidalı bağlantı.</li> </ul>	<p><b>Devre şeması</b></p> 	<p><b>Bağlantı şeması</b></p> 
<p> <b>Çocuk Korumalı İkili Topraklı Priz</b></p>	<p><b>Teknik Özellikler</b></p> <ul style="list-style-type: none"> <li>• 16 A, 250 V~</li> <li>• İki kutuplu ve kontak çubuğu biçimli topraklama kontaklı.</li> <li>• Vidalı bağlantı.</li> </ul>	<p><b>Devre şeması</b></p> 	<p><b>Bağlantı şeması</b></p> 

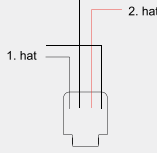
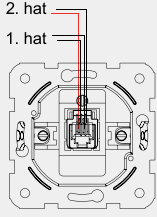

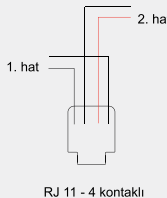
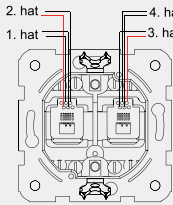
	Teknik Özellikler	Devre şeması	Bağlantı şeması
 <b>TV Prizi</b>	<ul style="list-style-type: none"><li>• Ekranlıdır. Havadan yayılan radyo sinyallerinden etkilenmez.</li><li>• Vidalı bağlantılıdır.</li><li>• Geçişli TV Prizi UHF/VHF bantlarından merkeze anten sistemiyle alınan yayının prizden prize geçiş yaparak veya çok katlı binalarda kattan kata geçirilerek birden fazla TV alıcısına dağıtıldığı durumlarda kullanılır.</li><li>• Sonlu TV Prizi İnternet, kablolu TV veya merkezi uydular gibi yayınların dağıtımı için kullanılan yıldız dağıtım sisteminde kullanılır. Ayrıca ortak anten sistemlerinin sonunda da kullanılabilir.</li><li>• Dirençsiz TV Prizi Bağımsız internet, kablolu TV veya uydular yayını sistemlerinde ve bağımsız antenli alıcılarla kullanılır.</li><li>• Amplifikatörden sonra takılacak olan priz, 20 dB, 18 dB, 12 dB, ve 8 dB'lik geçişli, sonlu ve dirençsiz prizler arasından 60-85 dBuV arasındaki TV sinyalinin seviyesine uygun olarak seçilmelidir.</li></ul>		  
 <b>TV - Radyo Prizi</b>	<ul style="list-style-type: none"><li>• Ekranlıdır. Havadan yayılan radyo sinyallerinden etkilenmez.</li><li>• Çabuk bağlantı (vidasız) klemenslidir.</li><li>• İnternet, interaktif uygulamalar, kablolu TV ve UHF / VHF bantlarından yayın alımında kullanılır.</li><li>• Amplifikatörden sonra takılacak olan priz, 20 dB, 15 dB, 12 dB, 10 dB ve 7 dB'lik ve sonlu prizler arasından 60-85 dBuV arasındaki TV sinyalinin seviyesine uygun olarak seçilmelidir.</li></ul>		
 <b>TV - SAT Prizi</b>	<ul style="list-style-type: none"><li>• Ekranlıdır. Havadan yayılan radyo sinyallerinden etkilenmez.</li><li>• Çabuk bağlantı (vidasız) klemenslidir.</li><li>• İnternet, interaktif uygulamalar, kablolu TV ve UHF / VHF bantlarından yayın alımında kullanılır.</li><li>• Amplifikatörden sonra takılacak olan priz, 11 dB, 8 dB'lik geçişli ve sonlu prizler arasından 60-85 dBuV arasındaki TV sinyalinin seviyesine uygun olarak seçilmelidir.</li></ul>		
 <b>TV - Radyo - SAT Prizi</b>	<p>İnternet, interaktif uygulamalar, kablolu TV ve UHF / VHF bantları ile uydular yayını alımında kullanılır.</p>		

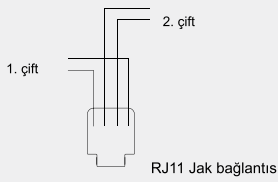
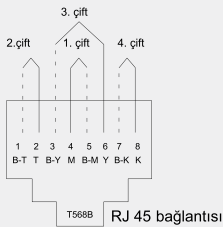
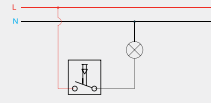
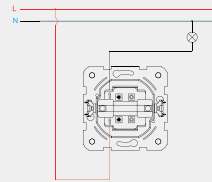
<p> <b>TV - Radyo - SAT - Sat Prizi</b></p>	<p><b>Teknik Özellikler</b></p> <ul style="list-style-type: none"> <li>• Ekranlıdır. Havadan yayılan radyo sinyallerinden etkilenmez.</li> <li>• Vidalı bağlantı klemenslidir.</li> <li>• İnternet, interaktif uygulamalar, kablolu TV ve UHF / VHF bantlarından yayın alımında kullanılır.</li> </ul>	<p><b>Devre şeması</b></p>	<p><b>Bağlantı şeması</b></p> 
<p> <b>Müzik Yayın (Hoparlör) Prizi</b></p>	<p><b>Teknik Özellikler</b></p> <ul style="list-style-type: none"> <li>• Müzik yayın kaynağından gelen yayının hoparlöre çıkışı için kullanılır.</li> <li>• 4Ω 5W uygulamalar için.</li> <li>• Vidalı bağlantılı klemenslidir.</li> </ul>	<p><b>Devre şeması</b></p> 	<p><b>Bağlantı şeması</b></p>
<p> <b>Nümeris Telefon Prizi</b></p>	<p><b>Teknik Özellikler</b></p> <ul style="list-style-type: none"> <li>• RJ11 4 kontaklıdır.</li> <li>• 2 telefon hattı bağlanabilir. Yeşil ve kırmızı teller 1. hat, sarı ve siyah teller de 2. hat içindir.</li> </ul>	<p><b>Devre şeması</b></p> 	<p><b>Bağlantı şeması</b></p> 
<p> <b>İkili Nümeris Telefon Prizi</b></p>	<p><b>Teknik Özellikler</b></p> <ul style="list-style-type: none"> <li>• RJ11 4 kontaklıdır.</li> <li>• Her bir konnektör için 2 telefon hattı bağlanabilir. Yeşil ve kırmızı teller 1. hat, sarı ve siyah teller de 2. hat içindir.</li> </ul>	<p><b>Devre şeması</b></p>  <p>RJ 11 - 4 kontaklı</p>	<p><b>Bağlantı şeması</b></p>  <p>2 x RJ 11 - 4 kontaklı</p>
<p> <b>Data - Nümeris Telefon Prizi</b></p>	<p><b>Teknik Özellikler</b></p> <ul style="list-style-type: none"> <li>• Nümeris jackı RJ11 4 kontak.</li> <li>• Data Jackı EIA/TIA 568 standartlarına uygundur; RJ45</li> <li>• EIA/TIA 568 A ve B standartlarını destekler.</li> <li>• Pinler hem 568 A hem de 568 B'ye göre işaretlenmiştir.</li> </ul>	<p><b>Devre şeması</b></p>  <p>RJ11 Jak bağlantısı</p>	<p><b>Bağlantı şeması</b></p>  <p>T568B RJ 45 bağlantısı</p>
<p><b>E</b> <b>İpli Acil Uyarı Butonu</b></p>	<p><b>Teknik Özellikler</b></p> <ul style="list-style-type: none"> <li>• Bir uyarı sistemini aktif hale geçirmek için kullanılır.</li> <li>• 10 A, 250 V~</li> <li>• Bir kutuplu, bir yönlü.</li> <li>• Ani basmalı tip.</li> <li>• Vidalı veya vidasız (çabuk bağlantılı) montaj seçeneği.</li> </ul>	<p><b>Devre şeması</b></p> 	<p><b>Bağlantı şeması</b></p> 





## Tekli Data Prizi

### Teknik Özellikler

- EIA/TIA 568 standartlarına uygundur; RJ45
- EIA/TIA 568 A ve B standartlarını destekler.
- Pinler hem 568 A hem de 568 B'ye göre işaretlenmiştir.

### Devre şeması

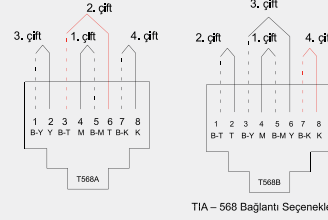

### Bağlantı şeması



## İkili Data Prizi

### Teknik Özellikler

- EIA/TIA 568 standartlarına uygundur; RJ45
- EIA/TIA 568 A ve B standartlarını destekler.
- Pinler hem 568 A hem de 568 B'ye göre işaretlenmiştir.

### Devre şeması

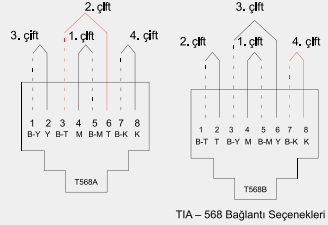

### Bağlantı şeması



## Standart Energy Saver

### Teknik Özellikler

- Başta otel odaları olmak üzere genel kullanımlı binalarda ciddi boyutlara varan enerji kaybını önlemek ve emniyeti sağlamak için kullanılır.
- Energy Saver Anahtarlığı duvar ünitesindeki yuvasına takılınca sisteme enerji verir. Kartı duvardaki yuvasından çıkartınca 15-20 sn. sonra sistemin enerjisi kesilir.
- Minibar gibi devamlı enerjili olan cihazlar sistemin dışında bırakılır.
- Sistemin by-pass özelliği vardır. (Energy Saver arızalandığında elektrik enerjisini kesmez.)
- Pano ünitesi çalışma gerilimi 175-250V'tur.
- Duvar ünitesi 12/24V gerilim vardır (220 V uygulayınız).
- Sigorta çıkışına takılan röle ünitesinde 3 x 10A röle vardır. Toplam 30A değerindedir.

### Devre şeması

### Bağlantı şeması

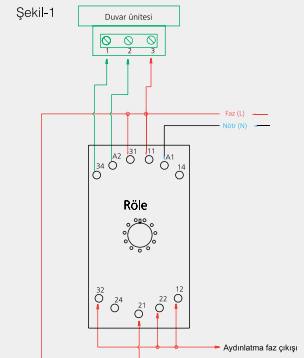

## İnce Kartlı Energy Saver

### Teknik Özellikler

- Başta otel odaları olmak üzere genel kullanımlı binalarda ciddi boyutlara varan enerji kaybını önlemek ve emniyeti sağlamak için kullanılır.
- Energy Saver, kartı duvar ünitesindeki yuvasına takınca sisteme enerji verir. Kartı duvardaki yuvasından çıkartınca 15-20 sn. sonra sistemin enerjisi kesilir.
- Minibar gibi devamlı enerjili olan cihazlar sistemin dışında bırakılır.
- Sistemin by-pass özelliği vardır. (Energy Saver arızalandığında elektrik enerjisini kesmez.)
- Pano ünitesi çalışma gerilimi 175-250V'tur.
- Duvar ünitesi 12/24V gerilim vardır (220 V uygulayınız).
- Sigorta çıkışına takılan röle ünitesinde iki adet 15A röle vardır. Biri aydınlatmayı, diğeri klimayı besler. İstendiğinde röle ünitesine üçüncü röle eklenebilir.
- Manyetik kapı kontağı ile kapı veya pencere açıldığında klima enerjisinin kesilmesi sağlanır.

### Devre şeması

### Bağlantı şeması

